

Rolety Cennik Detaliczny

www.shadow-system.pl

01.03.2025

PRODUCENT PLIS, ROLET I ŻALUZJI

shadow
SYSTEM



SHADOW-SYSTEM CENNIK DETALICZNY

Pamiętaj, że masz wpływ na wygląd i opracowanie folderów produktowych oraz cenników SHADOW-SYSTEM.
Cenimy sobie współpracę z naszymi klientami i opieramy ją na otwartej komunikacji.
Jeżeli masz uwagi lub pomysł jak udoskonalić materiały przygotowane przez nas, chętnie poznamy Twoją opinię.

SPIS TREŚCI

ROLETY WOLNOWISZĄCE

DECOMATIC® CLASSIC	05
Dopłaty	08
DECOMATIC® MEDIUM	12
Dopłaty	15
DECOMATIC® MEDIUM PLUS	18
Dopłaty	22
DECOMATIC® LARGE	24
Dopłaty	28
SMART S - COULISSE	30
Dopłaty	33
SMART M - COULISSE	35
Dopłaty	39
SMART L - COULISSE	40
Dopłaty	45

ROLETY NASKRZYDŁOWE

WSTĘP	46
RN BASIC	47
RN ULTIMATE - COULISSE	49
Dopłaty	51
ROLETY DECOMATIC®	52
Dopłaty	54

ROLETY DACHOWE

COULISSE SKYLIGHT	55
Dopłaty - napędy i sterowania elektryczne do rolet wolnowiszących	58
Ogólne Warunki Gwarancji	67

JAK KORZYSTAĆ Z CENNIKA? **TO PROSTE!** POSTĘPUJ ZGODNIE Z PONIŻSZĄ INSTRUKCJĄ!

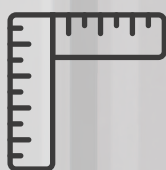

01. Wymiary

Dokonaj pomiaru, wybierz system i model rolety.



02. Cena

Z tabeli cenowej odczytaj cenę dla danego wymiaru, uwzględniając grupę cenową **(PG)** wybranej tkaniny.





03. Dopłaty

W sekcji dopłat znajdziesz ceny dopłat do modeli, napędów i sterowań elektrycznych oraz dodatków opcjonalnych.



04. Ważne

Zwróć uwagę na ikony   
Ich znaczenie znajdziesz na dole stron w dalszej części cennika.
W razie jakichkolwiek pytań prosimy o kontakt z Biurem Obsługi Klienta.

DECOMATIC® CLASSIC

**Ważne**

Szczegółowe informacje dotyczące wymiarów kaset, komponentów oraz konstrukcji systemów roletowych, znajdziesz w folderze produktowym. Folder dostępny jest również w wersji elektronicznej na naszej stronie internetowej.



www.shadow-system.pl

**Tabela podstawowa i dopłaty**

Tabela podstawowa dla modeli:
RC10, RC20 (str. 06-08).

Dopłaty do profilu nośnego i kasety dla modeli:
RC11, RC12, RC13, RC21, RC22, RC23, RC61, RC62, RC63 (str. 08).

Dopłaty do napędów elektrycznych dla modeli:
RC60, RC61, RC62, RC63 (str. 58 - 66).

**Kolory systemu CLASSIC**

**RAL
9016**

BIAŁY
LAKIEROWANY

E6/EV1

SREBRNY
ANODOWANY

**RAL
9005**

CZARNY
LAKIEROWANY

**Informacje.**

- 1 Do kalkulacji przyjmuje się całkowite wymiary zewnętrzne rolety wraz z kapkami bocznymi.
- 2 Roletę montujemy do ściany, sufitu lub skrzydła okiennego za pomocą wieszaków (klipsów), kątowników lub uchwytów bezinwazyjnych. W zestawie z gotową roletą otrzymasz komplet elementów standardowych niezbędnych do montażu danego modelu. Informacje odnośnie standardowych uchwytów montażowych do poszczególnych modeli rolet znajdziesz w naszym folderze produktowym.
- 3 Maksymalne szerokości tkanin roletowych podane są na stronach katalogowych poszczególnych kolekcji. W przypadku rolet o wymiarach zamówieniowych przekraczających te wartości, roleta może wymagać poziomego łączenia tkaniny (za dopłatą).

ROLETY CLASSIC

RC - ROLETY CLASSIC

ROLETY WOLNOWISZĄCE
DECOMATIC®

TABELA PODSTAWOWA

Podane ceny są cenami netto. Należy doliczyć VAT (23%)

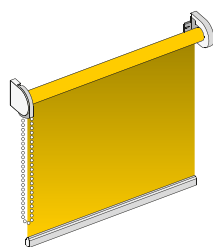

Maksymalna zalecana szerokość*: 240 cm.

Maksymalna zalecana wysokość*: 300 cm.

Wersje obstępowe*: łańcuszek, łańcuszek bezkońcowy,
mechanizm sprężynowy z blokadą
lub vario, napęd elektryczny.

Rury nawojowe: Ø 27 mm, Ø 32 mm

Mocowanie: ściana, sufit, skrzydło okienne,
wnęka okienna.

* w zależności od wybranego modelu rolety i tkaniny.

Szczegółowe informacje w folderze produktowym oraz katalogu tkanin.

		SZEROKOŚĆ																
PG		80	90	100	110	120	130	140	150	160	170	180	190	200	210	220	230	240
80	S	60	62	64	70	74	80	84	89	95	99	101	117	127	133	138	142	148
	0	73	75	78	81	84	89	93	99	105	109	115	137	142	148	153	159	164
	1	81	87	90	97	106	112	118	124	131	138	144	150	156	163	169	175	182
	2	92	99	103	110	118	123	131	138	144	153	162	176	184	191	199	207	214
	3	99	108	117	126	134	143	151	160	168	177	186	195	203	212	221	229	238
4	108	118	127	137	146	156	166	176	186	196	206	216	224	234	244	254	264	
90	S	62	64	66	73	77	82	87	92	97	101	106	120	131	138	143	149	153
	0	75	78	81	84	88	93	97	103	108	114	118	142	148	154	160	165	172
	1	84	90	95	101	110	117	123	131	137	144	151	157	164	171	177	184	190
	2	96	103	107	115	122	129	135	143	150	160	167	186	195	202	210	219	228
	3	104	114	122	132	141	150	160	169	178	187	197	206	216	224	233	243	253
4	114	123	134	145	155	165	176	187	197	208	218	229	239	250	259	270	280	
100	S	64	66	70	75	80	84	89	95	100	105	109	124	134	143	149	154	159
	0	78	81	83	88	92	97	101	107	111	117	122	146	154	160	166	173	178
	1	86	94	99	106	115	120	129	135	143	150	157	164	172	178	186	193	199
	2	99	107	110	118	127	134	141	149	155	164	172	196	205	213	222	231	239
	3	109	119	129	139	149	159	168	178	188	198	208	218	228	236	247	257	266
4	119	130	142	152	164	175	186	197	208	220	231	242	253	264	275	286	297	
110	S	69	72	74	80	83	88	93	99	105	109	116	131	140	148	154	159	178
	0	80	83	87	90	96	101	107	111	117	122	128	153	160	166	173	179	203
	1	89	97	103	110	119	127	134	142	150	156	164	172	178	186	194	201	240
	2	104	114	117	124	133	141	149	157	165	173	180	206	214	223	233	242	274
	3	114	124	134	145	155	166	176	187	198	208	218	229	239	250	261	270	312
4	124	137	149	161	173	184	196	208	220	231	243	255	267	278	290	302	345	
120	S	72	74	77	82	88	93	99	105	109	116	120	135	144	153	159	165	186
	0	82	86	89	95	100	106	110	117	122	128	133	160	166	173	179	187	212
	1	93	100	108	117	123	132	140	148	155	163	171	178	186	195	201	210	250
	2	108	118	123	132	140	149	157	165	174	183	190	214	224	234	244	254	286
	3	119	130	141	152	163	174	185	196	207	218	229	240	251	262	273	284	326
4	131	143	155	168	180	194	206	218	231	243	256	268	280	293	306	319	363	
130	S	75	78	81	86	92	97	103	108	115	120	127	141	151	157	164	171	190
	0	86	89	93	99	105	110	117	122	128	133	138	165	173	179	186	194	218
	1	96	104	112	120	129	137	144	153	162	169	177	186	194	201	210	219	257
	2	112	122	129	138	146	155	165	174	183	191	200	224	235	245	255	265	299
	3	123	135	148	159	171	182	194	205	217	229	240	252	263	275	286	298	341
4	137	150	163	176	189	202	216	229	242	255	268	281	295	308	321	334	379	
PG		80	90	100	110	120	130	140	150	160	170	180	190	200	210	220	230	240



Ceny z tabeli powyżej dotyczą modeli w wersjach:

łańcuszkowej RC10
sprężynowej RC20

Dopłaty do pozostałych modeli znajdziesz na stronie 08.



Dopłaty do napędów
elektrycznych i sterowania

znajdziesz na stronach 58 - 66.

		SZEROKOŚĆ																
PG		80	90	100	110	120	130	140	150	160	170	180	190	200	210	220	230	240
140	S	80	82	84	89	96	101	107	115	119	124	132	145	156	163	169	188	197
	0	89	93	97	103	109	116	120	128	133	138	144	172	178	186	194	214	224
	1	99	108	116	124	133	142	150	159	167	176	185	193	201	210	219	257	267
	2	117	128	135	144	153	164	173	183	191	200	212	234	245	255	266	298	312
	3	129	141	153	165	177	189	201	214	225	239	251	263	275	287	299	342	355
4	142	156	169	184	198	211	225	240	253	267	281	295	309	323	336	380	396	
150	S	83	86	88	93	100	106	111	118	123	131	135	152	162	168	174	194	205
	0	92	96	100	107	115	119	127	132	138	143	150	177	185	193	200	221	231
	1	103	111	120	129	138	146	155	164	173	183	190	200	209	218	227	266	276
	2	121	132	141	151	162	171	180	190	199	212	221	244	255	266	277	310	324
	3	133	146	160	172	185	197	210	223	235	248	262	274	287	300	312	356	369
4	148	162	177	191	206	221	235	250	264	279	293	308	323	337	352	397	413	
160	S	85	89	92	97	105	109	117	122	129	135	141	160	166	173	179	199	212
	0	95	100	105	110	118	123	131	137	143	149	155	183	190	198	207	227	239
	1	106	115	124	133	142	152	161	169	179	188	198	207	216	225	234	274	285
	2	124	137	146	157	168	178	189	198	211	221	230	253	265	277	288	322	338
	3	139	152	165	178	191	206	219	232	245	258	272	286	299	312	325	369	383
4	153	168	184	199	214	230	245	261	276	291	307	322	336	352	367	413	430	
170	S	87	92	95	101	108	116	120	128	134	140	145	164	171	178	196	207	218
	0	98	105	108	116	122	129	135	142	146	153	162	188	197	205	223	233	245
	1	108	118	128	138	148	156	166	176	185	195	205	214	223	233	272	282	293
	2	129	141	152	164	174	186	196	207	220	230	241	263	275	287	319	334	351
	3	143	157	172	185	199	213	227	241	255	269	282	297	311	324	368	382	398
4	160	175	191	207	223	239	255	272	287	302	319	334	351	367	412	428	446	
180	S	89	95	99	106	111	119	127	132	138	144	151	168	176	183	200	214	224
	0	100	108	111	119	127	133	140	145	152	161	168	194	202	211	230	241	253
	1	111	121	131	142	152	162	172	182	191	201	211	221	231	241	280	291	302
	2	133	145	159	171	180	194	205	217	227	240	251	273	286	298	331	347	364
	3	149	163	177	193	207	221	235	250	265	279	293	308	323	337	380	397	412
4	165	182	198	216	231	248	265	281	298	314	331	348	365	381	426	445	462	
190	S	92	99	103	109	117	123	131	137	143	150	157	173	180	188	208	220	231
	0	103	111	116	123	131	137	144	151	160	165	173	199	209	218	234	247	259
	1	115	126	135	145	156	166	176	187	198	208	218	229	239	248	288	300	311
	2	138	151	164	177	189	199	213	224	235	250	259	282	296	309	342	359	375
	3	153	168	184	198	213	229	244	259	274	289	304	320	334	349	393	410	426
4	171	188	206	222	240	257	275	292	310	326	344	361	378	396	443	460	479	
200	S	94	101	107	115	120	128	134	141	146	153	163	177	185	203	214	225	235
	0	106	115	119	128	134	142	149	157	164	172	178	206	214	230	242	254	267
	1	118	129	139	150	161	172	182	193	203	214	224	235	246	285	297	309	321
	2	142	155	168	183	196	208	221	232	244	257	270	291	306	336	355	370	390
	3	159	174	189	206	221	236	253	268	284	299	315	331	346	390	408	424	440
4	176	195	212	231	248	266	285	302	321	338	357	375	392	438	458	477	496	
210	S	96	104	110	118	124	132	140	145	152	161	167	183	190	208	221	232	243
	0	108	117	123	131	138	145	152	162	169	177	185	211	221	235	250	261	274
	1	121	132	143	154	165	176	187	198	209	220	231	243	254	292	304	318	330
	2	145	160	174	188	202	216	228	241	254	267	279	301	315	349	366	385	401
	3	163	179	196	211	228	244	261	277	293	309	325	342	358	402	421	438	455
4	182	201	220	239	257	276	295	313	332	351	369	388	406	453	473	493	513	
220	S	98	106	114	122	129	135	143	150	160	165	172	187	195	216	227	239	251
	0	110	120	127	134	142	150	160	167	174	183	189	218	227	243	256	268	279
	1	124	135	146	159	169	182	193	205	216	227	239	250	261	300	313	325	338
	2	150	165	179	194	209	223	235	251	263	276	288	311	325	359	378	396	414
	3	168	185	201	219	235	252	269	286	302	320	336	354	370	415	433	451	469
4	188	208	227	246	266	285	304	324	343	363	382	401	421	468	489	509	529	
230	S	99	108	117	124	133	141	146	155	163	171	177	191	208	221	232	244	257
	0	114	123	131	138	145	153	163	171	179	188	196	223	235	250	262	275	287
	1	128	139	151	163	174	186	198	209	221	233	245	256	296	308	321	334	347
	2	154	169	185	199	214	230	244	258	272	285	301	321	353	370	390	409	426
	3	173	190	208	225	243	261	278	295	312	330	347	365	409	427	446	465	483
4	194	213	234	254	274	293	314	334	354	375	394	414	461	482	504	525	547	
240	S	101	110	119	127	135	144	151	161	168	174	183	196	216	227	240	252	263
	0	116	126	134	142	150	161	168	176	185	194	200	229	242	256	269	280	296
	1	130	142	155	166	179	191	203	216	228	240	252	264	302	317	330	343	356
	2	159	174	189	205	221	236	252	267	280	296	310	330	364	382	401	420	440
	3	177	196	214	232	250	268	286	304	322	340	358	376	421	440	459	479	499
4	199	220	241	262	282	303	324	345	366	386	406	427	475	498	519	541	563	

WYSOKOŚĆ

		SZEROKOŚĆ																	
PG		80	90	100	110	120	130	140	150	160	170	180	190	200	210	220	230	240	
WYSOKOŚĆ	250	S	104	112	121	130	139	148	156	165	172	179	188	200	221	232	244	257	270
		0	118	129	138	145	153	164	172	180	189	198	207	234	250	262	276	287	302
		1	133	146	159	171	184	196	209	221	233	246	258	270	310	324	337	352	365
		2	163	178	195	211	228	243	259	275	288	304	319	340	374	393	413	435	453
		3	183	201	220	239	257	276	295	313	332	351	369	388	433	453	472	492	513
	4	206	227	248	269	291	312	334	355	377	398	420	440	489	512	535	557	580	
	260	S	106	115	123	133	142	151	160	168	177	186	194	214	225	239	252	263	277
		0	121	131	141	150	161	168	177	186	195	205	213	242	254	268	280	296	308
		1	137	150	163	175	188	201	214	227	240	253	265	303	318	332	346	360	374
		2	167	184	200	217	233	250	266	282	299	313	329	365	386	405	424	446	464
		3	188	207	227	245	264	284	303	322	342	360	379	424	445	466	485	506	526
	4	211	233	255	277	299	322	344	366	388	410	432	480	503	526	550	573	596	
	270	S	108	117	127	135	144	154	163	173	180	189	197	220	231	244	257	270	282
		0	123	134	144	153	164	172	180	190	199	211	220	247	261	275	287	302	314
		1	140	153	166	179	193	206	219	232	245	258	272	311	325	340	354	368	383
		2	171	188	206	222	240	256	274	290	307	323	340	375	396	415	438	457	477
		3	193	212	232	252	272	291	311	331	351	370	390	436	457	478	499	519	541
	4	217	240	263	285	308	331	354	377	399	422	445	493	517	541	566	590	614	
	280	S	110	119	129	139	148	157	166	176	186	195	203	224	239	251	263	277	288
		0	126	138	149	160	168	177	187	196	206	216	224	253	267	280	296	308	323
1		143	156	169	184	197	211	224	239	252	265	279	318	333	347	363	377	392	
2		175	193	210	228	245	263	280	298	315	332	349	386	408	428	448	469	489	
3		197	218	239	258	279	299	320	341	360	381	401	447	469	490	512	534	556	
4	222	246	269	292	317	340	364	387	410	434	458	506	532	556	581	605	630		
290	S	111	121	131	141	151	161	171	179	189	199	208	230	243	257	269	282	297	
	0	129	140	151	163	172	180	190	199	212	221	230	259	274	286	302	314	330	
	1	145	160	174	188	201	216	230	244	257	272	304	325	341	355	370	386	401	
	2	179	197	216	234	252	269	288	306	324	342	358	396	417	439	459	481	501	
	3	202	223	244	265	286	307	329	349	370	391	436	458	481	503	525	547	570	
4	228	252	277	301	325	349	374	398	422	446	494	519	545	571	596	622	647		
300	S	114	124	133	143	154	164	174	184	194	203	214	234	250	262	276	288	303	
	0	131	143	155	165	176	186	196	206	216	225	234	265	278	295	308	322	336	
	1	149	164	177	193	207	221	235	250	264	278	311	332	348	364	379	394	410	
	2	184	202	220	239	258	277	295	313	332	351	368	408	428	449	473	493	513	
	3	207	229	251	272	293	315	336	358	380	401	447	470	493	515	538	561	584	
4	234	258	284	309	333	358	383	408	433	458	506	533	559	585	612	638	663		
PG		80	90	100	110	120	130	140	150	160	170	180	190	200	210	220	230	240	
		SZEROKOŚĆ																	

DOPLĄTY DO PROFILU NOŚNEGO I KASETY

(cena z tabeli podstawowej + dopłata)

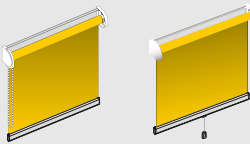
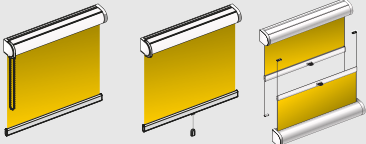
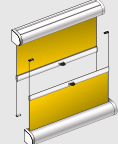
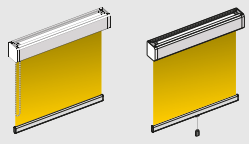
PROFIL NOŚNY	KASETA		
	OKRĄGŁA	KWADRATOWA	
			
RC11 / RC 61 RC21	RC12 / RC62 RC22	RC52	RC13 / RC63 RC23

		SZEROKOŚĆ																
PG		80	90	100	110	120	130	140	150	160	170	180	190	200	210	220	230	240
PROFIL NOŚNY		20	24	25	27	30	31	33	36	38	40	42	44	47	49	51	53	55
KASETA		67	75	82	88	95	103	109	116	122	129	135	143	150	156	163	169	177



Dopłaty do napędów elektrycznych i sterowania znajdziesz na stronach 58 - 66.

RC-ROLETY CLASSIC

OPCJE DODATKOWE

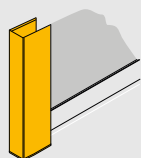

Profile boczne typu „U” (kpl. P+L)

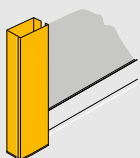

Profile boczne dzielone, dwuczęściowe (kpl. P+L)

Dodatki do profili bocznych dzielonych:

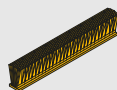

Szczotka uszczelniająca
o wysokości 9 mm

2,65 € /mb.

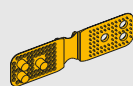

Napinacz tkaniny
w kolorze białym

0,55 € /szt.

NAZWA	PROFILE BOCZNE TYPU „U”	PROFILE BOCZNE DZIELONE
80	24	84
90	26	93
100	29	103
110	31	112
120	33	122
130	36	131
140	39	141
150	41	151
160	43	161
170	45	169
180	49	179
190	51	189
200	54	199
210	56	208
220	59	218

WYSOKOŚĆ

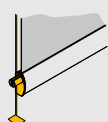

Prowadzenie boczne
(linka boczna + mocowanie dolne standard)

26,00 € /kpl.



Łańcuszek metalowy
ze spinką / bezkońcowy

zzgl. 3,10 € /mb.
łańcuszka obrotowego*



Łańcuszek bezkońcowy PVC

zzgl. 7,40 € /szt.



Profil dolny zamykający
ze szczotką uszczelniającą.

17,90 € /mb.

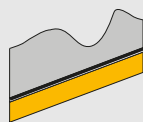

Volant prosty

nieobszty: **45,00 € /mb.**
obszty: **68,00 € /mb.**

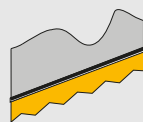

Volant trójkąt

45,00 € /mb.
68,00 € /mb.

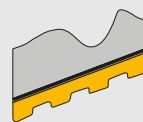

Volant prostokąt

45,00 € /mb.
68,00 € /mb.

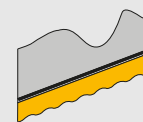

Volant fala

45,00 € /mb.
68,00 € /mb.

* długość łańcuszka obrotowego -> (0,75 x wysokość zamówieniowa rolety) x2

index 2174

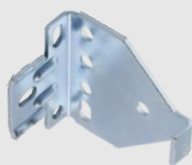

Wspornik długi 45 mm
ocynk

1,90 € /szt.

index 2175



Wspornik regulowany
ocynk

3,85 € /szt.

index 2140



Klips płaski / wygięty
Kolor: biały, stalowy

1,70 € /szt.
 2,85 € /szt.

index 2132



Uchwyt bezinwazyjny do rolet na wspornikach
Kolory: biały, szary, czarny, brązowy

7,50 € /szt.

index 2133



Uchwyt bezinwazyjny do rolet na profilu nośnym i w kasie
Kolor: biały

7,50 € /szt.

index 2150



Uchwyt bezinwazyjny, zaciskowy do prowadzenia bocznego
Kolory: biały, szary, czarny

7,50 € /szt.

index 2136



Kątownik 33mm
Kolory: alu, biały

6,45 € /szt.
 10,75 € /szt.

index 2142



Kątownik regulowany 60 - 108 mm
Kolory: alu, biały

6,45 € /szt.
 7,25 € /szt.

index 2143



Kątownik regulowany 108 - 156 mm
Kolory: alu, biały

15,25 € /szt.
 19,00 € /szt.

index 2144



Kątownik regulowany 156 - 204 mm
Kolory: alu, biały

21,65 € /szt.
 24,15 € /szt.



Element stosowany jako mocowanie standardowe w odpowiednim modelu rolety. Nie należy uwzględniać go przy dokonywaniu wyceny - jedynie jeśli zamawiany jest dodatkowo. Więcej informacji o mocowaniach znajdziesz w folderze produktowym.

index 1234

Elementy dodatkowe zostały oznaczone indeksami, z których można korzystać podczas składania zamówień. Zamiast podawania pełnej nazwy elementu wystarczy posłużyć się przypisanym numerem indeksu.

Czy wiesz że



Do każdej rolety dołączany jest komplet standardowych uchwytów montażowych. W przypadku wyboru opcjonalnego sposobu montażu, konieczne jest dodanie ceny za wybrany uchwyt. Informacje odnośnie standardowych i opcjonalnych uchwytów montażowych dla poszczególnych modeli rolet znajdują się w folderze produktowym.

RC-ROLETY CLASSIC

ELEMENTY DODATKOWE

index 2181



Łańcuszek metalowy

* **4,45 €** /mb

Spinka łańcuszka (metal.) **2182**

* **0,75 €** /szt.

index 2179



Łańcuszek PVC
Kolory: biały, szary, czarny, brązowy

* **2,10 €** /mb

Spinka łańcuszka (PVC) **2180**

* **0,55 €** /szt.

index 2048



Obciążnik łańcuszka
Kolory biały, szary lub czarny

2,30 € /szt.

* Cena zakupu samego łańcuszka lub spinki.

Wycena krok po kroku



Dane przyjęte do wyceny zostały oznaczone kolorem **czzerwonym**.

Na potrzeby kalkulacji przyjęliśmy następujące parametry:

Wymiary - 118,5 cm x 143 cm
Model - RC11
Tkanina - S-0884 RO (PG: S)
Dodatki - prowadzenie boczne



1. Dokonaj pomiaru, **118,5 cm x 143 cm** (szerokość x wysokość)
2. Z tabeli odczytaj cenę dla zaokrąglonego w górę wymiaru, uwzględniając grupę cenową (PG) wybranej tkaniny, (**120 cm x 150 cm 100 €**)
3. Wybierz odpowiedni model rolety **RC11** - cena z tabeli podstawowej + dopłata za profil nośny (**30,00 €**)
4. Dodatkowo wybieramy **prowadzenie boczne (26,00 €)**
5. Końcowa cena detaliczna (**100 € + 30 € + 26 €**)
156,00 €



WAŻNE



Do wyceny rolety z napędem elektrycznym konieczne jest dodanie ceny za wybrany silnik elektryczny. Dopłata zawiera montaż napędu w roletcie oraz ustalenie położeń krańcowych rolety. Ceny dopłat za napędy elektryczne i sterowanie znajdziesz na str. 58 - 66.

DECOMATIC® MEDIUM



Ważne

Szczegółowe informacje dotyczące wymiarów kaset, komponentów oraz konstrukcji systemów roletowych, znajdziesz w folderze produktowym. Folder dostępny jest również w wersji elektronicznej na naszej stronie internetowej.



www.shadow-system.pl



Tabela podstawowa i dopłaty

Tabela podstawowa dla modelu:
RM10 (str. 13-15).

Dopłaty do profilu nośnego i kasety dla modeli:
RM11, RM12, RM13, RM61, RM62, RM63 (str. 15).

Dopłaty do napędów elektrycznych dla modeli:
RM60, RM61, RM62, RM63 (str. 47).



Kolory systemu MEDIUM

**RAL
9016**

BIAŁY
LAKIEROWANY

E6/EV1

SREBRNY
ANODOWANY

**RAL
9005**

CZARNY
LAKIEROWANY



Informacje

- 1 Do kalkulacji przyjmuje się całkowite wymiary zewnętrzne rolety wraz z kapkami bocznymi.
- 2 Roletę montujemy do ściany, sufitu lub we wnęce okiennej za pomocą wieszaków (klipsów), kątowników lub uchwytów bezinwazyjnych. W zestawie z gotową roletą otrzymasz komplet elementów standardowych niezbędnych do montażu danego modelu. Informacje odnośnie standardowych uchwytów montażowych do poszczególnych modeli rolet znajdziesz w naszym folderze produktowym.
- 3 Maksymalne szerokości tkanin roletowych podane są na stronach katalogowych poszczególnych kolekcji. W przypadku rolet o wymiarach zamówieniowych przekraczających te wartości, roleta może wymagać poziomego łączenia tkaniny (za dopłatą).

ROLETY MEDIUM

TABELA PODSTAWOWA

Podane ceny są cenami netto. Należy doliczyć VAT (23%)



Maksymalna zalecana szerokość*: 280 cm.
Maksymalna zalecana wysokość*: 300 cm.
Wersje obsługowe*: łańcuszek, łańcuszek bezkońcowy, napęd elektryczny.
Mocowanie: ściana, sufit lub wnęka okienna.
Rury nawojowe: Ø 29 mm, Ø 38 mm, Ø 44 mm.
Długość obsługi: 75% wysokości całkowitej rolety.

* w zależności od wybranego modelu rolety i tkaniny.

Szczegółowe informacje w folderze produktowym oraz katalogu tkanin.

		SZEROKOŚĆ																			
		PG	100	110	120	130	140	150	160	170	180	190	200	210	220	230	240	250	260	270	280
100	S		77	81	88	92	99	104	109	116	120	137	146	160	168	178	189	198	212	221	229
	0		91	96	101	107	112	118	123	129	134	163	173	185	195	205	217	226	239	247	255
	1		108	117	124	133	141	149	157	167	174	188	197	219	227	237	248	261	275	288	301
	2		122	131	138	146	155	164	172	179	188	220	229	245	260	273	285	294	306	315	326
	3		143	154	165	176	187	198	209	220	230	249	263	278	294	309	324	339	353	369	384
110	S		80	87	92	97	102	109	116	120	128	143	153	164	174	186	196	206	218	226	239
	0		95	100	105	112	118	123	129	134	140	170	179	191	200	214	223	235	245	256	264
	1		115	122	132	140	146	157	165	173	182	196	203	226	236	245	258	271	285	299	312
	2		129	138	145	155	164	173	180	191	198	229	240	259	273	286	297	308	319	328	340
	3		150	161	173	184	196	206	219	229	241	263	279	296	311	326	342	357	373	389	406
120	S		83	91	96	101	108	115	120	126	133	149	161	171	180	192	203	215	224	235	245
	0		99	104	111	117	123	129	134	141	145	176	187	197	212	221	230	242	254	264	276
	1		119	129	137	145	155	164	173	180	191	202	225	235	244	252	268	280	294	309	327
	2		136	144	153	164	173	182	191	199	212	239	258	270	285	297	309	320	332	343	372
	3		155	167	179	192	203	216	227	240	251	278	294	311	327	344	361	376	393	410	425
130	S		89	95	100	107	115	119	126	132	138	155	167	177	188	198	213	222	231	243	254
	0		102	109	116	122	128	134	141	145	152	182	194	204	217	226	240	250	262	271	285
	1		124	134	143	152	163	172	180	189	198	210	234	242	251	262	276	291	306	319	338
	2		142	151	162	172	180	191	200	213	221	248	268	284	297	309	321	333	344	356	390
	3		162	175	187	200	213	225	238	250	263	293	310	327	344	363	380	397	413	431	448
140	S		92	99	105	111	118	124	132	137	143	162	173	185	195	206	218	227	241	251	262
	0		107	115	120	126	133	140	145	152	160	188	199	214	223	235	247	259	270	283	294
	1		131	140	149	160	170	178	188	197	206	217	240	250	261	271	286	300	315	338	348
	2		149	160	170	179	191	199	213	222	230	259	279	296	308	321	333	345	357	391	406
	3		172	185	198	210	223	237	250	263	276	308	326	344	362	380	398	414	433	451	469
150	S		96	102	109	117	123	131	137	143	149	168	178	191	200	215	224	236	247	260	270
	0		111	118	124	132	138	144	151	160	165	195	206	220	230	242	254	267	278	289	303
	1		134	144	154	165	175	185	195	204	215	224	247	259	268	279	294	310	325	347	359
	2		155	167	177	188	198	212	221	230	242	268	290	307	319	332	345	359	370	406	420
	3		179	194	206	221	235	249	262	277	291	324	342	361	377	398	415	435	453	473	490
	4		197	213	228	246	261	277	293	309	325	357	377	399	418	439	459	481	501	522	542
		PG	100	110	120	130	140	150	160	170	180	190	200	210	220	230	240	250	260	270	280



Ceny z tabeli powyżej dotyczą modelu w wersji:
łańcuszkowej RM10
Dopłaty do pozostałych modeli znajdziesz na stronie 15.



Dopłaty do **napędów elektrycznych i sterowania** znajdziesz na stronach 58 - 66.

		SZEROKOŚĆ																		
PG		100	110	120	130	140	150	160	170	180	190	200	210	220	230	240	250	260	270	280
160	S	100	107	115	120	129	136	142	149	155	173	186	197	208	221	231	243	255	268	278
	0	116	122	129	137	143	150	157	164	172	200	215	225	239	250	262	275	286	299	311
	1	139	149	160	170	179	191	200	210	221	244	255	266	277	289	303	319	334	357	368
	2	162	173	185	196	206	220	229	242	252	287	303	317	331	344	357	370	384	420	437
	4	205	223	241	256	273	291	308	324	340	374	396	417	438	459	482	502	525	544	567
170	S	104	112	119	126	133	140	146	153	162	179	192	203	216	226	240	251	262	275	286
	0	119	126	134	141	149	155	163	171	177	208	221	231	244	258	270	283	294	307	320
	1	142	153	164	174	185	196	206	217	227	250	263	273	285	298	313	328	344	367	380
	2	168	179	192	204	217	227	241	252	265	299	314	327	342	355	369	383	396	436	450
	4	217	235	251	269	287	303	323	339	357	392	413	436	458	481	502	525	548	570	593
180	S	109	117	123	131	138	144	151	161	167	186	197	212	222	234	245	259	270	283	296
	0	123	131	138	145	152	162	170	176	185	215	226	240	252	265	277	289	303	315	328
	1	146	157	168	179	191	201	213	223	235	259	270	282	293	307	323	338	365	376	389
	2	174	187	199	214	224	239	250	262	276	310	324	339	352	367	382	395	435	450	465
	4	204	221	237	252	269	285	301	318	333	368	388	409	430	450	472	492	513	533	555
190	S	115	120	129	136	142	150	157	165	172	192	204	217	227	241	254	265	278	289	303
	0	128	136	143	150	160	167	174	182	191	221	234	245	260	271	285	299	311	324	339
	1	150	162	173	185	196	206	219	229	241	265	277	289	301	317	332	348	374	387	399
	2	178	193	206	221	234	247	260	273	286	319	334	348	364	377	393	408	448	464	479
	4	236	255	275	293	312	332	351	371	389	425	450	474	497	521	544	570	594	616	640
200	S	118	124	133	141	146	155	163	171	178	197	213	223	235	249	261	270	286	299	311
	0	132	140	146	155	164	172	179	188	196	226	241	252	267	279	294	307	319	332	346
	1	154	166	177	189	201	213	224	237	259	272	285	297	310	325	340	357	384	396	410
	2	184	198	214	227	242	256	269	284	298	328	344	360	374	390	406	420	461	477	493
	4	221	239	256	273	292	309	327	344	362	398	419	443	462	486	507	531	554	575	597
210	S	122	131	137	144	152	162	168	176	185	204	217	229	242	256	267	276	294	307	319
	0	136	143	151	162	170	177	186	195	203	234	247	261	275	287	302	313	327	341	355
	1	158	170	182	195	205	219	230	243	267	279	292	306	318	333	350	367	393	407	420
	2	189	203	219	235	249	265	279	294	308	339	353	370	386	402	417	433	473	491	508
	4	255	276	297	318	338	361	381	402	422	459	486	512	536	562	587	613	639	664	689
220	S	126	134	142	150	157	165	173	180	189	212	223	236	249	262	272	287	302	314	327
	0	140	146	157	165	174	182	192	199	212	240	254	268	280	296	308	322	336	350	364
	1	162	174	187	199	212	224	237	248	273	287	300	313	326	343	360	389	404	417	431
	2	194	210	225	241	258	272	288	303	319	348	365	381	396	413	430	470	487	504	521
	4	266	287	308	330	351	373	396	417	438	478	503	530	557	582	608	636	662	687	714
230	S	131	138	145	153	163	171	178	187	195	217	229	243	256	268	278	297	310	322	334
	0	143	151	162	171	178	188	197	205	216	245	260	275	287	303	315	330	345	359	370
	1	166	178	192	203	217	229	242	255	280	293	308	321	334	351	369	398	413	428	441
	2	199	216	231	247	264	280	296	312	330	359	374	391	408	425	441	482	499	517	535
	4	247	267	286	307	326	345	365	384	405	443	465	490	515	538	563	587	612	637	661
240	S	133	142	150	161	168	176	185	192	199	223	235	249	262	273	284	303	315	330	343
	0	146	157	165	174	185	194	203	214	222	252	267	280	297	310	324	339	352	366	382
	1	170	182	196	209	222	236	248	273	287	301	314	328	343	361	377	408	422	437	451
	2	204	221	238	254	271	288	304	324	341	367	385	402	418	436	454	495	513	532	550
	4	285	308	331	353	376	402	424	448	472	512	538	567	596	624	651	680	708	737	764
250	S	137	145	155	164	172	180	189	197	206	227	242	256	268	279	289	311	324	339	351
	0	151	162	171	179	189	198	208	218	226	260	273	287	303	317	331	346	361	374	390
	1	174	187	200	215	227	241	254	280	293	308	322	336	351	370	387	417	432	447	462
	2	210	226	244	261	278	296	312	334	351	376	394	412	431	448	466	508	527	544	563
	4	263	285	307	327	348	370	391	411	433	473	497	523	551	575	601	626	651	678	703
		294	318	342	367	391	414	439	462	488	529	558	586	614	644	675	703	730	760	788
PG		100	110	120	130	140	150	160	170	180	190	200	210	220	230	240	250	260	270	280

		SZEROKOŚĆ																		
PG		100	110	120	130	140	150	160	170	180	190	200	210	220	230	240	250	260	270	280
260	S0	139	149	158	168	177	186	195	203	214	235	249	262	273	285	304	317	332	346	360
	1	155	165	174	186	195	204	215	224	234	265	279	296	310	324	340	355	368	385	398
	2	177	192	204	219	234	246	261	286	301	315	330	344	361	377	411	426	441	457	472
	3	215	231	249	267	286	303	321	345	362	387	405	423	441	459	501	520	539	558	578
	4	272	294	317	338	361	382	404	424	447	487	513	538	565	594	618	645	674	699	725
270	S0	302	328	353	377	405	429	454	479	503	544	576	605	636	664	693	725	754	784	813
	1	141	151	162	172	182	191	199	208	218	241	256	268	279	290	311	325	340	355	367
	2	161	170	179	189	199	212	221	229	241	271	286	302	317	332	347	362	375	392	408
	3	181	196	210	224	238	251	266	292	308	322	338	351	369	387	419	436	451	467	482
	4	220	238	256	275	292	311	328	356	372	396	415	434	453	471	513	533	553	572	592
280	S0	280	302	326	348	371	393	415	438	460	501	529	557	582	609	637	664	690	719	746
	1	312	339	365	391	415	444	469	494	520	562	594	625	655	685	716	747	777	807	837
	2	143	154	165	175	186	196	205	216	223	247	261	273	285	296	319	332	347	361	374
	3	164	173	185	195	204	216	225	236	245	278	294	310	324	340	355	369	386	399	415
	4	186	199	215	228	243	259	284	299	314	330	345	361	376	397	429	445	461	477	493
290	S0	225	244	263	282	300	319	347	366	385	406	425	444	464	482	525	545	565	585	605
	1	289	312	335	360	382	406	429	453	477	516	543	572	601	628	655	683	710	739	766
	2	323	349	375	404	430	456	483	511	536	579	611	643	676	706	737	769	801	831	861
	3	146	156	167	178	189	200	213	221	229	252	267	278	289	301	325	341	355	368	385
	4	167	178	188	198	212	221	230	242	252	285	301	315	331	347	362	377	393	410	423
300	S0	192	203	219	235	248	264	290	306	321	336	351	368	385	406	438	454	470	487	503
	1	229	249	268	288	307	326	356	374	394	415	435	455	474	494	537	558	579	599	619
	2	297	322	345	370	393	417	443	465	489	531	560	587	616	645	676	703	730	760	787
	3	332	361	387	414	444	470	497	527	554	597	629	661	693	726	759	789	824	855	888
	4	149	160	171	181	193	203	217	225	235	260	271	284	294	317	332	347	362	375	391
PG	100	110	120	130	140	150	160	170	180	190	200	210	220	230	240	250	260	270	280	

DOPLĄTY DO PROFILU NOŚNEGO I KASETY

(cena z tabeli podstawowej + dopłata)

<p>PROFIL NOŚNY</p>  <p>RM11 / RM61</p>	<p>OKRĄGŁA</p>  <p>RM12 / RM62</p>	<p>KWADRATOWA</p>  <p>RM13 / RM63</p>
---	--	---

		SZEROKOŚĆ																		
PG		100	110	120	130	140	150	160	170	180	190	200	210	220	230	240	250	260	270	280
PROFIL NOŚNY		25	27	30	31	33	35	38	40	42	45	47	49	51	53	54	56	59	62	63
KASETA		119	129	139	149	158	170	179	189	200	210	220	229	241	250	261	271	282	291	301

RM-ROLETY MEDIUM

OPCJE DODATKOWE

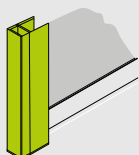

Profile boczne MEDIUM
ze szczotką uszczelniającą
(kpl. P+L).

NAZWA	PROFILE BOCZNE
100	132
110	142
120	154
130	165
140	176
150	187
160	198
170	209
180	221
190	230
200	243
210	254
220	265
230	276
240	287
250	298
260	310
270	321
280	332
290	343
300	353

WYSOKOŚĆ

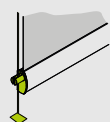

Prowadzenie boczne
(linka boczna + mocowanie
dolne standard)

29,00 € /kpl.



Łańcuszek metalowy
ze spinką / bezkońcowy

3,10 € /mb
łańcuszka obsługowego*



Łańcuszek bezkońcowy
PVC

7,40 € /szt.

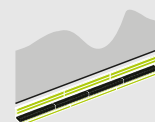

Profil dolny zamykający
ze szczotką uszczelniającą.

17,90 € /mb.

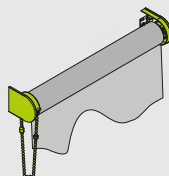

Zestaw dekoracyjny RM10
(metalowe kapy boczne w kolorze
chrom lub szampańskim
oraz metalowy łańcuszek)

75,00 € /kpl.

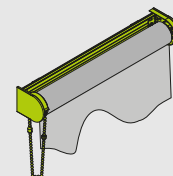

Zestaw dekoracyjny RM11
(metalowy profil nośny, kapy boczne
oraz łańcuszek)

75,00 €
+ 33,00 € /mb.
szerokości rolety

* długość łańcuszka obsługowego -> (0,75 x wysokość zamówieniowa rolety) x2

Czy wiesz że



Do każdej rolety dołączany jest komplet standardowych uchwytów montażowych. W przypadku wyboru opcjonalnego sposobu montażu, konieczne jest dodanie ceny za wybrany uchwyt. Informacje odnośnie standardowych i opcjonalnych uchwytów montażowych dla poszczególnych modeli rolet znajdują się w folderze produktowym.

RM-ROLETY MEDIUM

ELEMENTY DODATKOWE

index 2176

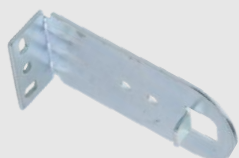

Wspornik długi 61 mm
ocynk

2,95 € /szt.

index 2177



Wspornik do montażu
we wnęce okiennej
ocynk

3,10 € /szt.

index 2172



Klips płaski MEDIUM
w kolorze białym lub alu.

1,70 € /szt.



index 2138



Kątownik
w kolorze białym
lub anodowanym

7,90 € /szt.

index 2142



Kątownik regulowany
60 - 108 mm
w kolorze białym lub alu.

- 6,45 € /szt.
- 7,25 € /szt.

index 2143

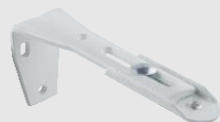

Kątownik regulowany
108 - 156 mm
w kolorze białym lub alu.

- 15,25 € /szt.
- 19,00 € /szt.

index 2144



Kątownik regulowany
156 - 204 mm
w kolorze białym lub alu.

- 21,65 € /szt.
- 24,15 € /szt.

index 2150



Uchwyt bezinwazyjny,
zaciskowy do
prowadzenia bocznego.
Kolory: biały, szary, czarny.

7,50 € /szt.

index 2181



Łańcuszek metalowy

*4,45 € /mb.

index 2179



Łańcuszek PVC

*2,10 € /mb.

index 2048



Obciążnik łańcuszka
w kolorze białym, szarym
lub czarnym.

2,30 € /szt.



Spinka łańcuszka (metal.)

*0,75 € /szt.

2182



Spinka łańcuszka (PVC)

*0,55 € /szt.

2180

* Cena zakupu samego łańcuszka lub spinki.

Element stosowany jako mocowanie standardowe w odpowiednim modelu rolety.



Nie należy uwzględniać go przy dokonywaniu wyceny - jedynie jeśli zamawiany jest dodatkowo. Więcej informacji o mocowaniach znajdziesz w folderze produktowym.

Elementy dodatkowe zostały oznaczone indeksami, z których można korzystać podczas składania zamówień. Zamiast podawania pełnej nazwy elementu wystarczy posłużyć się przypisanym numerem indeksu.

index 1234



WAŻNE



Do wyceny rolety z napędem elektrycznym konieczne jest dodanie ceny za wybrany silnik elektryczny. Dopłata zawiera montaż napędu w roletcie. Montaż silnika powierzony jest za dodatkową dopłatą. Ceny dopłat za napędy elektryczne i sterowanie znajdziesz na str. 58 - 66.

DECOMATIC® MEDIUM PLUS



Ważne

Szczegółowe informacje dotyczące wymiarów kaset, komponentów oraz konstrukcji systemów roletowych, znajdziesz w folderze produktowym. Folder dostępny jest również w wersji elektronicznej na naszej stronie internetowej.



www.shadow-system.pl



Tabela podstawowa i dopłaty

Tabela podstawowa dla modelu:
RMP10 (str. 19-21).

Dopłaty do profilu nośnego i kasety dla modeli:
RMP11, RMP12, RMP13, RMP14, RMP61, RMP62, RMP63, RMP64 (str. 21).

Dopłaty do napędów elektrycznych dla modeli:
RM60, RM61, RM62, RM63 (str. 47).



Informacje

- 1 Do kalkulacji przyjmuje się całkowite wymiary zewnętrzne rolety wraz z kapkami bocznymi.
- 2 Roletę montujemy do ściany, sufitu lub we wnęce okiennej za pomocą wieszaków (klipsów), kątowników lub uchwytyw bezinwazyjnych. W zestawie z gotową roletą otrzymasz komplet elementów standardowych niezbędnych do montażu danego modelu. Informacje odnośnie standardowych uchwytów montażowych do poszczególnych modeli rolet znajdziesz w naszym folderze produktowym.
- 3 Maksymalne szerokości tkanin roletowych podane są na stronach katalogowych poszczególnych kolekcji. W przypadku rolet o wymiarach zamówieniowych przekraczających te wartości, roleta może wymagać poziomego łączenia tkaniny (za dopłatą).



Kolory systemu MEDIUM

**RAL
9016**

BIAŁY
LAKIEROWANY

E6/EV1

SREBRNY
ANODOWANY

**RAL
9005**

CZARNY
LAKIEROWANY

ROLETY MEDIUM PLUS

ROLETY WOLNOWISZĄCE
DECOMATIC®

RMP-ROLETY MEDIUM PLUS

TABELA PODSTAWOWA

Podane ceny są cenami netto. Należy doliczyć VAT (23%)

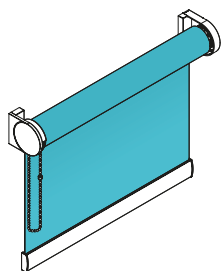

Maksymalna zalecana szerokość*: 320 cm.
 Maksymalna zalecana wysokość*: 340 cm.
 Wersje obsługowe*: łańcuszek, łańcuszek bezkońcowy, napęd elektryczny.
 Mocowanie: ściana, sufit lub wnęka okienna.
 Rury nawojowe: Ø 38 mm, Ø 44 mm, Ø 52 mm
 Długość obsługi: 75% wysokości całkowitej rolety.

* w zależności od wybranego modelu rolety i tkaniny.

Szczegółowe informacje w folderze produktowym oraz katalogu tkanin.

		SZEROKOŚĆ																															
PG		100	110	120	130	140	150	160	170	180	190	200	210	220	230	240	250	260	270	280	290	300	310	320									
100	S	122	130	138	144	152	160	167	175	181	189	197	204	213	219	226	235	242	249	280	288	297	304	313									
	0	130	139	147	155	164	172	180	188	197	204	214	222	229	239	246	255	263	271	303	312	321	330	340									
	1	139	149	157	166	176	185	194	203	213	222	230	240	249	259	267	277	286	297	327	338	347	357	367									
	2	155	166	177	188	199	210	220	230	242	252	264	275	286	296	307	318	328	340	373	385	396	408	419									
	3	167	179	192	202	215	226	239	250	263	275	287	299	311	322	334	348	365	381	406	418	431	444	456									
110	4	179	193	206	220	234	246	260	272	286	299	312	325	339	351	365	382	398	415	441	455	469	483	497									
	S	125	133	141	149	156	164	172	179	187	195	202	210	218	225	234	241	248	279	287	296	304	313	322									
	0	134	143	151	160	168	177	186	195	203	212	220	228	238	246	255	264	271	303	312	322	331	341	350									
	1	143	153	163	172	181	192	200	210	220	229	239	248	259	267	277	287	297	328	339	349	360	369	381									
	2	161	173	184	195	206	218	228	241	251	263	275	286	297	309	320	331	343	375	388	401	413	425	437									
120	3	174	186	199	212	223	237	248	262	273	287	299	312	324	338	351	368	385	410	423	436	450	467	483									
	4	187	201	216	228	243	258	271	285	299	313	326	341	355	369	386	405	420	447	461	478	495	515	533									
	S	128	136	144	152	160	168	176	184	192	200	208	216	224	231	240	248	256	286	294	303	312	322	331									
	0	138	146	155	164	174	182	192	200	209	218	226	237	245	254	263	271	280	312	322	332	342	350	361									
	1	147	157	167	177	187	197	208	218	227	238	247	258	267	277	287	297	307	340	349	361	371	388	406									
130	2	166	178	191	202	215	226	238	249	262	273	286	297	309	321	333	345	357	391	404	416	429	447	467									
	3	180	194	206	220	234	246	260	272	286	299	312	325	339	353	371	388	406	426	440	455	470	488	503									
	4	195	209	224	239	254	268	283	298	312	326	342	356	371	389	410	425	445	467	483	502	521	540	560									
	S	131	139	147	155	164	172	180	188	197	205	214	222	229	239	246	255	285	293	302	312	321	330	341									
	0	141	151	160	168	178	187	197	205	216	224	235	243	252	262	271	280	311	321	331	342	351	362	444									
140	1	152	162	173	182	194	203	215	224	235	245	255	266	276	287	297	308	339	350	362	372	384	397	479									
	2	172	185	197	209	222	235	246	260	271	284	297	309	321	333	346	359	392	406	418	432	449	473	543									
	3	186	200	215	227	242	255	269	284	297	311	324	339	353	373	390	410	429	444	461	480	497	516	588									
	4	202	218	234	248	264	279	294	310	325	341	356	372	390	412	430	450	470	490	508	529	548	567	640									
	S	133	142	151	160	167	176	185	194	202	210	219	227	237	244	252	262	291	301	310	320	328	339	419									
150	0	144	154	164	174	182	193	202	213	221	230	241	250	260	269	279	289	320	330	341	350	362	371	455									
	1	156	167	177	188	199	210	221	230	242	252	264	275	285	296	307	318	349	362	372	385	395	410	491									
	2	178	191	203	217	229	242	255	268	282	294	307	320	333	346	360	371	407	419	434	447	467	492	561									
	3	193	206	222	237	250	265	279	293	309	323	338	353	372	390	411	426	446	465	483	502	520	539	609									
	4	210	225	242	259	273	290	307	323	339	355	371	390	412	431	453	472	493	513	534	555	575	595	663									
S	137	145	154	163	172	180	189	198	206	216	224	234	242	250	260	268	299	308	318	327	338	346	429										
150	0	147	158	168	178	188	198	208	218	227	238	247	258	267	277	287	297	328	340	350	361	371	383	466									
	1	161	172	182	194	204	216	227	239	249	261	271	283	294	306	317	327	361	372	385	396	408	419	504									
	2	184	197	210	223	238	250	264	277	291	304	318	332	345	359	371	386	419	434	448	462	486	512	578									
	3	199	215	229	244	260	275	290	304	320	335	351	371	389	411	428	448	466	488	504	523	542	562	629									
	4	217	235	250	268	285	301	319	335	351	369	389	412	431	453	473	495	516	538	559	580	602	624	686									
PG	100	110	120	130	140	150	160	170	180	190	200	210	220	230	240	250	260	270	280	290	300	310	320										



Ceny z tabeli powyżej dotyczą modelu w wersji:
łańcuszkowej RMP10
 Dopłaty do pozostałych modeli znajdziesz na stronie 21.



Dopłaty do **napędów elektrycznych i sterowania**
 znajdziesz na stronach 58 - 66.

SZEROKOŚĆ

PG	100	110	120	130	140	150	160	170	180	190	200	210	220	230	240	250	260	270	280	290	300	310	320	
160	S	140	149	157	166	176	185	194	202	213	221	229	239	248	258	266	275	306	315	325	335	345	355	437
	0	152	162	172	182	193	203	214	223	235	244	254	265	275	285	296	306	338	348	360	370	382	393	477
	1	164	176	187	199	212	222	235	245	258	268	280	291	303	314	326	338	370	384	395	408	420	433	517
	2	189	202	217	230	245	259	272	287	301	314	328	343	357	370	385	398	434	449	464	479	506	534	595
	3	205	221	238	252	268	285	300	315	331	347	368	387	409	426	448	467	489	507	528	545	565	585	649
4	224	242	260	277	294	312	330	347	365	386	409	430	451	473	496	517	540	561	585	607	629	651	710	
170	S	142	152	161	171	179	189	198	208	217	226	236	245	254	264	272	283	313	323	333	343	353	364	446
	0	155	166	176	187	198	208	219	229	240	250	262	271	283	292	303	314	346	357	369	381	392	404	487
	1	168	180	193	204	217	228	241	252	264	276	288	300	312	324	336	348	382	394	407	419	433	445	531
	2	195	209	223	238	252	267	282	296	311	325	340	353	368	384	397	412	448	464	479	494	519	548	613
	3	213	228	245	261	277	293	310	326	343	364	384	406	424	446	466	489	508	529	550	569	590	609	669
4	231	250	268	287	306	323	342	361	380	405	425	449	472	495	517	540	564	587	611	635	657	681	733	
180	S	145	155	164	174	184	193	202	213	222	230	241	250	261	269	279	310	320	330	341	350	362	441	455
	0	158	170	180	192	202	214	224	236	246	258	268	279	290	301	312	343	355	367	377	390	402	483	497
	1	173	185	198	210	222	235	247	260	271	284	297	309	321	333	346	380	392	406	418	432	445	529	543
	2	200	215	229	245	261	275	290	306	320	335	350	366	381	395	411	446	462	478	494	510	527	612	630
	3	219	236	252	269	286	303	320	338	353	380	399	420	443	464	487	507	529	550	571	593	614	669	689
4	240	259	278	297	315	335	353	372	392	420	445	468	493	516	540	562	587	612	634	657	680	734	756	
190	S	147	157	167	177	187	197	206	217	226	237	246	256	266	276	286	317	326	338	348	360	369	450	464
	0	162	174	185	196	206	219	229	241	251	264	275	286	297	309	320	351	364	375	388	399	412	494	509
	1	177	191	202	216	227	241	254	266	279	292	304	318	330	343	356	389	402	416	430	444	457	540	557
	2	205	221	237	251	268	284	299	314	330	346	362	376	392	408	424	460	475	492	509	525	541	628	647
	3	225	243	261	278	296	313	331	348	366	392	416	438	460	483	503	528	550	571	593	615	637	689	710
4	247	267	287	307	326	346	366	386	406	438	464	489	513	537	561	587	612	635	659	683	707	758	781	
200	S	151	161	171	181	192	201	212	222	231	242	251	262	272	283	292	323	334	345	356	367	377	459	472
	0	166	177	189	200	213	223	236	246	259	270	282	293	304	317	327	361	372	385	397	410	422	504	519
	1	181	195	208	221	235	247	261	273	287	300	313	326	340	352	366	398	413	428	441	455	469	554	569
	2	212	226	243	260	276	291	308	324	340	356	372	388	405	420	436	473	490	508	523	541	558	644	664
	3	231	249	268	286	304	322	341	359	376	411	432	456	477	499	521	545	570	592	615	638	661	708	730
4	255	275	296	315	336	357	377	397	418	457	481	508	534	557	582	611	634	659	685	711	738	781	804	
210	S	154	164	175	185	195	205	216	226	237	247	258	268	278	288	299	330	341	352	364	374	386	467	481
	0	170	181	193	204	217	228	241	252	265	277	288	300	312	324	336	368	382	394	407	419	432	515	531
	1	186	199	213	226	240	252	267	280	293	308	321	334	348	362	375	410	424	438	453	467	481	565	582
	2	217	234	249	266	284	300	317	333	349	366	384	399	416	433	449	487	504	521	539	557	575	662	682
	3	238	258	276	294	313	332	350	369	388	424	449	470	495	518	542	566	590	614	637	661	684	728	750
4	263	285	306	327	347	371	391	414	435	473	499	528	553	579	605	632	658	684	710	737	762	803	827	
220	S	156	167	178	188	199	210	220	230	242	251	263	273	285	294	306	336	348	360	371	383	394	475	489
	0	173	185	197	209	222	235	246	259	270	283	296	308	320	332	344	376	390	404	416	430	443	525	540
	1	189	203	218	231	245	260	273	287	301	315	330	343	357	371	385	419	434	449	464	479	493	579	595
	2	222	240	256	273	290	308	325	342	360	376	393	411	429	445	462	499	518	536	555	572	590	679	699
	3	244	265	285	304	323	343	364	383	404	440	464	490	513	537	561	586	611	634	658	682	706	748	771
4	273	296	317	340	363	385	409	430	451	492	518	544	573	600	627	655	682	708	737	763	790	826	851	
230	S	160	171	181	193	203	215	224	236	246	258	268	279	290	301	332	344	355	367	380	390	470	485	497
	0	176	189	201	215	226	239	251	264	277	289	302	314	327	340	372	386	398	412	425	439	520	536	552
	1	194	208	222	238	251	266	280	294	309	323	338	351	366	381	414	430	445	460	475	491	573	591	608
	2	227	245	263	280	298	317	334	351	369	387	405	422	440	458	495	514	533	551	569	587	675	695	716
	3	255	275	294	315	336	355	375	394	416	456	479	504	531	555	580	605	630	656	681	707	745	767	790
4	284	306	330	351	375	398	422	445	468	510	538	566	593	623	650	677	706	733	761	789	823	849	874	
240	S	162	174	185	196	206	218	228	241	251	263	273	285	297	308	339	350	363	374	387	397	478	492	507
	0	179	193	205	219	230	244	258	270	283	296	309	322	335	347	381	394	408	422	435	449	531	546	562
	1	198	214	227	242	258	271	287	301	317	331	346	361	374	390	424	440	456	471	487	502	585	604	621
	2	234	251	269	288	306	324	343	361	380	397	415	434	451	470	509	528	545	565	584	603	690	711	733
	3	263	285	304	326	346	368	389	411	431	469	496	520	548	573	599	625	651	676	703	728	763	787	810
4	293	317	341	365	388	414	437	461	487	528	555	585	614	642	670	701	729	759	787	816	845	874	902	
250	S	165	176	188	199	212	222	235	245	256	268	279	291	302	313	345	357	369	382	393	407	487	501	515
	0	184	197	210	223	237	249	263	276	289	302	315	328	342	355	388	402	416	431	445	458	540	557	573
	1	202	218	234	247	263	278	293	309	323	339	353	369	385	398	434	450	466	482	497	514	597	616	635
	2	239	258	276	294	313	333	351	370	389	408	426	445	464	482	520	540	560	580	600	619	706	728	750
	3	270	293	315	338	360	382	404	423	446	488	513	539	566	592	618	644	670	699	724	751	782	806	831
4	303	327	351	377	404	426	453	477	502	543	575	604	633	664	693	724	752	783	812	843	872	902	932	
260	S	168																						

		SZEROKOŚĆ																						
PG		100	110	120	130	140	150	160	170	180	190	200	210	220	230	240	250	260	270	280	290	300	310	320
280	S	174	186	198	210	222	236	247	260	271	284	296	308	321	351	365	377	391	404	416	495	511	527	541
	0	194	208	222	237	250	265	279	293	308	322	336	350	365	397	413	428	443	458	473	554	571	588	605
	1	216	230	247	264	280	297	313	330	346	363	377	394	411	446	464	481	497	515	533	615	635	654	674
	2	255	276	296	317	336	357	376	397	418	438	459	479	499	539	560	581	602	624	644	731	755	779	802
	3	298	322	345	370	392	417	441	466	491	532	560	590	618	647	675	704	731	761	789	819	847	876	905
290	4	333	361	387	415	443	469	497	527	553	596	629	663	695	727	759	791	825	856	888	919	951	982	1015
	S	177	189	201	215	226	239	251	264	277	289	301	314	326	359	371	385	397	411	424	503	518	534	551
	0	197	213	226	241	255	270	285	299	314	328	343	357	372	406	420	436	451	467	482	563	581	599	616
	1	219	237	252	269	286	303	320	336	352	370	387	404	419	456	473	491	509	527	543	627	647	666	686
	2	261	282	302	323	344	365	386	407	428	449	470	491	512	552	573	594	616	638	660	747	771	795	819
300	3	306	332	355	382	406	430	456	479	503	545	577	605	635	665	695	724	752	783	811	839	870	899	929
	4	342	371	398	426	457	485	513	541	570	615	648	681	714	748	782	813	849	880	914	949	981	1016	1048
	S	179	193	204	218	230	243	256	268	282	294	307	320	333	364	377	391	405	418	432	511	528	542	559
	0	201	216	230	245	261	275	290	306	320	335	349	365	380	413	430	445	460	475	492	573	591	609	627
	1	223	241	258	275	292	309	326	344	361	377	394	412	430	465	483	501	519	537	555	639	659	679	700
310	2	266	288	309	331	351	373	394	416	437	459	480	502	522	563	586	608	630	653	676	763	787	811	836
	3	314	341	366	390	417	443	467	494	518	562	593	624	654	683	712	745	774	804	833	864	894	924	953
	4	351	382	412	440	468	498	529	556	587	633	667	702	735	769	803	836	872	906	938	973	1005	1040	1071
	S	182	196	208	221	235	247	261	273	287	299	312	325	339	370	385	397	412	425	439	518	535	552	566
	0	204	220	236	249	265	280	296	311	326	342	356	371	387	420	437	453	469	486	501	583	601	619	638
320	1	227	245	263	280	298	315	333	350	368	386	404	420	438	474	493	512	530	548	566	650	670	691	712
	2	271	293	315	338	360	382	404	425	447	469	491	513	535	577	599	621	644	667	689	779	804	829	853
	3	323	349	374	401	428	454	480	507	532	577	608	639	670	701	730	763	792	825	854	885	916	947	977
	4	362	391	423	451	481	513	541	570	603	649	685	719	754	789	824	858	895	930	962	997	1031	1066	1099
	S	185	198	213	225	239	251	265	278	291	304	318	331	344	376	391	405	418	433	447	528	543	559	576
330	0	208	223	239	255	270	286	301	317	332	348	364	380	394	429	445	461	478	494	511	593	612	630	649
	1	231	249	268	286	303	322	340	357	375	393	411	430	447	485	503	521	540	559	578	662	683	704	726
	2	277	300	322	345	367	390	412	435	457	480	502	525	546	588	612	635	659	682	705	794	819	846	871
	3	331	357	384	411	439	465	491	520	544	592	624	655	687	718	749	782	812	845	875	907	937	971	1001
	4	370	402	433	462	493	525	557	585	617	666	703	739	774	809	845	879	917	952	986	1022	1057	1092	1126
340	S	188	201	216	228	242	256	269	283	297	310	323	338	368	384	397	412	426	440	518	535	552	567	584
	0	212	227	243	260	275	291	307	322	339	353	370	386	419	437	454	470	487	503	583	603	621	640	659
	1	237	254	272	291	310	327	346	365	383	401	419	438	474	493	513	532	552	570	653	675	695	717	738
	2	283	306	328	351	374	397	420	444	467	490	513	536	577	601	625	649	672	697	784	809	835	861	888
	3	339	367	393	419	449	477	503	533	558	606	639	672	704	735	766	801	832	865	896	929	959	993	1024
350	4	380	411	445	475	506	538	570	600	634	682	721	756	792	829	865	902	940	976	1011	1047	1082	1120	1154
	S	192	204	219	231	246	260	273	288	301	315	328	343	374	389	405	418	433	448	527	542	559	577	593
	0	215	230	247	264	280	296	312	328	345	361	376	393	428	445	461	479	495	513	593	612	632	651	669
	1	241	260	278	297	315	334	352	371	390	409	428	446	483	503	522	541	561	581	664	686	707	729	751
	2	288	312	335	360	383	407	430	454	477	499	523	546	588	614	638	662	686	710	798	826	852	878	905
360	3	346	375	404	430	460	488	515	544	571	619	654	687	721	753	785	821	852	884	917	950	982	1016	1048
	4	388	420	455	487	517	552	583	614	649	700	738	775	812	850	887	924	962	1000	1035	1071	1107	1145	1181
	PG	100	110	120	130	140	150	160	170	180	190	200	210	220	230	240	250	260	270	280	290	300	310	320

DOPLĄTY DO PROFILU NOŚNEGO I KASET

(cena z tabeli podstawowej + dopłata)

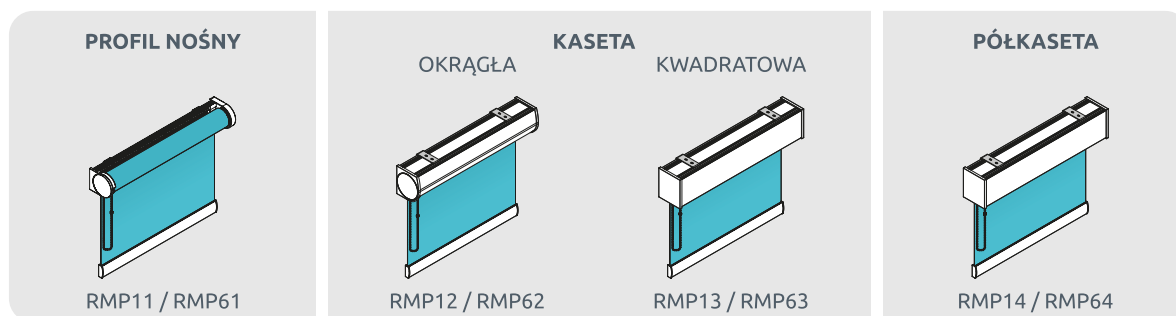

		SZEROKOŚĆ																						
		100	110	120	130	140	150	160	170	180	190	200	210	220	230	240	250	260	270	280	290	300	310	320
PROFIL NOŚNY		56	62	68	72	79	83	90	94	100	107	112	117	123	129	134	138	145	151	157	161	167	173	178
PÓŁ-KASETA		153	167	180	195	208	222	236	249	264	277	291	304	319	332	346	361	373	388	402	415	430	443	457
KASETA		193	210	227	245	263	280	298	315	333	350	368	386	404	420	438	456	473	491	509	527	543	561	580

RMP-ROLETY MEDIUM PLUS

ROLETY WOLNOWISZĄCE
DECOMATIC®

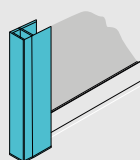

Profile boczne MEDIUM
ze szczotką uszczelniającą
(kpl. P+L).

	PROFILE BOCZNE	
100		132
110		144
120		156
130		168
140		180
150		194
160		205
170		218
180		229
190		242
200		255
210		267
220		279
230		291
240		303
250		317
260		328
270		341
280		353
290		366
300		377
310		390
320		402
330		415
340		428

WYSOKOŚĆ

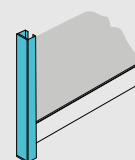

Profile prowadzenia bocznego MEDIUM PLUS
(kpl. P+L).

	PROFILE PROW. BOCZNEGO	
100		65
110		70
120		74
130		79
140		84
150		91
160		96
170		100
180		105
190		112
200		117
210		122
220		128
230		132
240		138
250		143
260		149
270		154
280		158
290		164
300		170
310		175
320		180
330		186
340		191

WYSOKOŚĆ

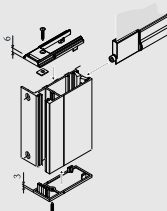

Montaż we wnęce.

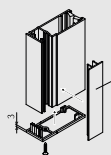

Montaż poza wnęką.

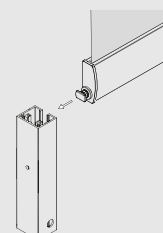

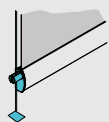

Prowadzenie boczne
(linka boczna + mocowanie
dolne standard)

67,00 € /kpl.



**Łańcuszek bezkońcowy
PVC**

7,40 € /szt.



**Łańcuszek metalowy
ze spinką / bezkońcowy**

3,10 € /mb.
łańcuszka obsługowego**

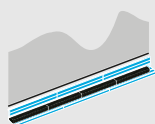

Profil dolny zamykający
ze szczotką uszczelniającą.

30,50 € /mb.

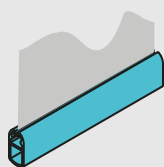

Obciążnik „SLIM”
dostępny w kolorach
systemowych

opcja alternatywna
BEZ DOPŁATY

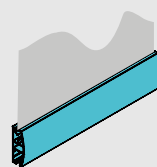

Obciążnik „PLUS”

25,00 € /mb.

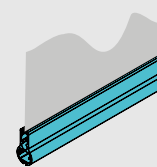

Obciążnik „LARGE”

25,00 € /mb.

ELEMENTY DODATKOWE

index 2181



Łańcuszek metalowy

***4,45 €** /mb.

index 2179



Łańcuszek PVC

***2,10 €** /mb.



Spinka łańcuszka (metal.)

***0,75 €** /szt.

2182



Spinka łańcuszka (PVC)

***0,55 €** /szt.

2180

* cena zakupu samego łańcuszka lub spinki.

** długość łańcuszka obsługowego -> (0,75 x wysokość zamówieniowa rolety) x2

index 1234

Elementy dodatkowe zostały oznaczone indeksami, z których można korzystać podczas składania zamówień. Zamiast podawania pełnej nazwy elementu wystarczy posłużyć się przypisanym numerem indeksu.



Ważne

Szczegółowe informacje dotyczące wymiarów kaset, komponentów oraz konstrukcji systemów roletowych, znajdziesz w folderze produktowym. Folder dostępny jest również w wersji elektronicznej na naszej stronie internetowej.



www.shadow-system.pl



Tabela podstawowa i dopłaty

Tabela podstawowa dla modelu:
RL10 (str. 25-27).

Dopłaty do profilu nośnego i kasety dla modeli:
RL11, RL12, RL13, RL61, RL62, RL63 (str. 28).

Dopłaty do napędów elektrycznych dla modeli:
RL60, RL61, RL62, RL63 (str. 47).



Informacje

- 1 Do kalkulacji przyjmuje się całkowite wymiary zewnętrzne rolety wraz z kapkami bocznymi.
- 2 Roletę montujemy do ściany, sufitu lub we wnęce okiennej za pomocą wieszaków (klipsów). W zestawie z gotową roletą otrzymasz komplet elementów standardowych niezbędnych do montażu danego modelu. Informacje odnośnie standardowych uchwytów montażowych do poszczególnych modeli rolet znajdziesz w naszym folderze produktowym.
- 3 Maksymalne szerokości tkanin roletowych podane są na stronach katalogowych poszczególnych kolekcji. W przypadku rolet o wymiarach zamówieniowych przekraczających te wartości, roleta może wymagać poziomego łączenia tkaniny (za dopłatą).



Kolory systemu LARGE

**RAL
9016**

BIAŁY
LAKIEROWANY

E6/EV1

SREBRNY
ANODOWANY

**RAL
9005**

CZARNY
LAKIEROWANY

**RAL
9006**

SZARY
LAKIEROWANY

ROLETY LARGE

ROLETY WOLNOWISZĄCE
DECOMATIC®

RL-ROLETY
LARGE

TABELA
PODSTAWOWA

Podane ceny są cenami netto. Należy doliczyć VAT (23%)

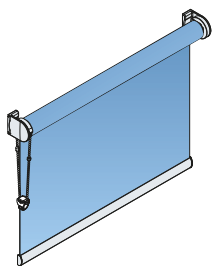

Maksymalna zalecana szerokość* : 400 cm.
 Maksymalna zalecana wysokość* : 400 cm.
 Wersje obsługowe* : łańcuszek, łańcuszek bezkońcowy, napęd elektryczny.
 Mocowanie: ściana, sufit lub wnęka okienna.
 Rury nawojowe: Ø 43 mm, Ø 52 mm, Ø 65 mm
 Długość obsługi: 75% wysokości całkowitej rolety.

* w zależności od wybranego modelu rolety i tkaniny.

Szczegółowe informacje w folderze produktowym oraz katalogu tkanin.

		SZEROKOŚĆ																																						
PG		100	110	120	130	140	150	160	170	180	190	200	210	220	230	240	250	260	270	280	290	300	310	320	330	340	350	360	370	380	390	400								
130	S	161	173	184	196	208	219	230	242	254	265	277	288	300	311	323	334	346	357	369	381	392	405	477	490	503	516	530	543	557	570	583								
	0	172	185	197	210	222	236	247	261	272	286	298	311	323	336	348	362	373	387	398	412	424	437	511	525	539	555	569	583	597	612	627								
	1	182	197	210	224	238	251	265	278	292	306	320	333	347	361	374	388	402	415	430	443	457	470	544	561	577	592	607	623	638	655	669								
	2	204	220	237	251	267	284	299	315	331	347	363	380	394	411	426	443	458	473	490	506	521	537	614	632	649	667	685	703	721	738	755								
	4	236	254	273	292	311	331	349	368	387	407	425	444	464	482	501	520	539	558	577	596	615	634	713	734	755	776	797	818	838	859	880								
140	S	164	176	188	200	213	223	236	247	260	270	283	294	307	319	330	342	353	366	377	390	401	413	486	499	513	528	540	555	567	582	716								
	0	176	189	201	215	227	241	254	267	280	292	306	319	332	345	359	370	384	396	410	423	436	449	522	537	553	566	582	597	612	627	762								
	1	187	201	216	229	244	259	272	286	300	314	328	343	357	371	386	399	413	428	441	456	470	485	559	576	591	607	624	639	656	670	808								
	2	210	226	243	260	276	292	309	325	342	359	374	391	408	424	440	457	473	490	507	522	539	556	633	651	668	687	706	725	742	761	899								
	4	243	263	283	302	322	342	362	382	401	420	440	460	480	499	519	539	559	579	599	618	638	658	739	761	782	804	826	847	869	890	1032								
150	S	167	179	192	203	217	228	241	252	265	277	289	301	313	325	338	349	362	373	386	398	411	423	495	510	523	537	552	565	580	594	728								
	0	179	193	206	220	234	246	260	273	287	300	313	326	340	353	367	381	393	407	420	434	447	460	535	551	564	580	595	611	626	641	776								
	1	192	206	221	236	250	265	279	293	309	323	338	352	367	382	395	411	425	439	455	469	483	497	573	590	606	623	639	656	672	688	826								
	2	217	234	250	267	285	301	319	335	352	369	387	404	420	437	455	471	489	506	522	539	557	573	651	669	688	708	727	746	764	783	922								
	4	251	271	292	313	334	353	374	395	415	436	457	477	497	518	539	559	580	601	620	641	662	683	764	786	809	831	853	876	898	921	1064								
160	S	171	182	196	208	220	234	245	259	270	283	296	308	320	333	345	357	370	383	394	408	419	491	506	519	534	548	562	577	591	605	740								
	0	184	197	212	224	239	251	266	279	293	307	321	334	348	363	375	390	404	417	431	445	458	531	546	562	578	593	608	625	640	656	791								
	1	197	212	226	242	256	271	287	301	317	332	346	362	376	391	407	422	436	451	467	482	496	571	587	604	621	638	656	672	688	706	844								
	2	222	240	258	275	292	310	327	345	363	381	397	415	433	450	468	486	503	520	538	556	575	650	669	689	708	728	748	767	786	806	947								
	4	260	280	302	323	345	366	387	409	430	451	472	494	515	536	558	579	601	621	642	664	685	765	789	812	835	858	881	905	928	951	1095								
170	S	174	187	199	213	224	238	250	263	276	289	301	314	326	340	352	365	377	390	404	416	429	501	515	530	544	559	573	587	603	734	752								
	0	187	201	216	229	244	259	271	286	300	314	328	343	357	370	385	398	413	428	441	455	469	542	558	575	591	606	623	638	655	787	807								
	1	201	217	231	247	263	278	293	309	324	340	356	371	387	402	417	433	448	464	479	494	510	584	602	619	637	654	670	688	706	840	860								
	2	227	246	265	283	301	319	338	355	373	391	410	429	446	465	482	501	518	537	555	573	591	668	688	708	729	749	769	788	808	947	970								
	4	246	267	287	307	326	347	367	387	407	428	447	467	487	507	528	546	566	586	607	627	647	726	748	770	791	813	835	857	879	1019	1043								
180	S	177	191	203	217	228	242	255	268	282	294	308	321	334	346	360	372	386	398	412	425	438	510	525	539	555	570	584	600	614	747	764								
	0	192	205	220	235	249	264	278	292	307	322	336	350	365	380	393	409	423	437	451	466	481	554	570	586	603	619	636	653	668	803	822								
	1	205	221	238	252	269	285	301	317	333	348	365	381	396	412	429	444	460	475	492	508	522	599	616	634	651	668	687	705	723	857	878								
	2	235	252	271	290	309	327	346	365	384	404	422	440	459	478	496	515	534	553	571	590	608	686	707	728	748	769	789	810	831	970	993								
	4	254	275	294	315	336	357	377	398	418	439	460	481	502	522	543	563	584	605	626	647	667	747	770	791	814	836	859	882	905	1045	1070								
PG		100	110	120	130	140	150	160	170	180	190	200	210	220	230	240	250	260	270	280	290	300	310	320	330	340	350	360	370	380	390	400								



Ceny z tabeli powyżej dotyczą modelu w wersji:
łańcuszkowej RL10
 Dopłaty do pozostałych modeli znajdziesz na stronie 28.



Dopłaty do **napędów elektrycznych i sterowania** znajdziesz na stronach 58 - 66.

		SZEROKOŚĆ																																						
PG		100	110	120	130	140	150	160	170	180	190	200	210	220	230	240	250	260	270	280	290	300	310	320	330	340	350	360	370	380	390	400								
190	S	180	194	206	220	234	247	261	273	287	300	313	327	341	353	367	381	393	407	420	434	447	519	535	550	564	580	595	611	626	759	776								
	0	195	210	225	240	255	269	285	299	314	328	344	359	373	388	404	417	433	447	462	477	492	565	582	599	616	633	649	665	682	816	836								
	1	210	226	243	260	276	291	308	324	341	357	373	390	407	422	438	455	471	488	504	520	537	612	630	648	666	684	703	722	739	875	896								
	2	240	260	279	298	318	336	356	374	394	414	433	453	472	491	511	530	550	567	587	607	626	705	726	747	769	789	810	831	853	992	1016								
	3	261	282	303	324	346	367	389	410	432	453	474	495	516	538	559	581	602	624	644	666	687	767	791	814	837	860	884	907	930	1071	1098								
4	284	307	331	353	377	401	425	449	472	496	519	543	566	591	614	638	661	685	708	732	756	838	864	889	916	941	966	992	1017	1161	1189									
200	S	184	197	212	224	238	251	265	279	292	307	320	333	347	361	374	388	401	415	429	443	456	529	543	560	576	591	606	621	637	771	788								
	0	199	215	229	245	260	275	290	306	321	336	351	366	382	396	412	428	443	457	472	488	503	578	594	612	628	645	662	680	697	831	851								
	1	215	231	248	265	282	299	315	332	348	366	383	398	416	433	449	466	483	499	516	533	551	626	644	663	682	701	719	738	755	893	913								
	2	246	266	286	306	325	345	366	386	406	425	445	465	485	504	523	544	564	584	604	624	643	723	745	766	787	809	831	853	875	1015	1039								
	3	267	289	311	333	356	377	399	422	444	466	488	510	532	554	576	597	619	641	664	686	708	789	812	836	860	885	908	932	956	1098	1124								
4	291	315	341	365	389	413	438	462	487	511	536	560	584	608	633	658	682	706	730	755	780	863	889	916	942	969	995	1021	1047	1191	1220									
210	S	187	200	215	228	242	256	270	285	298	312	326	340	353	368	382	395	410	423	437	451	522	538	554	570	585	601	617	633	649	782	801								
	0	203	219	235	249	265	280	297	312	327	343	359	374	390	406	420	436	451	468	483	498	571	588	606	624	641	659	676	692	710	846	867								
	1	219	237	254	270	288	306	322	340	357	373	391	409	425	443	460	477	494	512	529	545	620	639	659	678	697	716	734	753	773	909	931								
	2	251	272	293	313	334	353	374	395	415	436	457	477	497	518	538	559	580	600	620	640	718	740	763	785	808	830	852	874	897	1036	1062								
	3	275	297	320	343	365	388	411	433	456	479	501	523	546	569	592	615	637	660	683	706	785	810	834	858	884	908	932	957	981	1124	1151								
4	299	324	349	373	399	425	450	475	501	527	552	577	602	627	653	678	703	727	752	777	859	887	914	941	969	996	1022	1049	1077	1221	1251									
220	S	191	204	219	231	246	261	275	289	303	318	332	346	361	374	389	404	417	432	446	460	532	548	563	580	595	612	628	643	775	794	812								
	0	206	223	239	255	270	287	302	319	334	350	366	383	397	414	430	446	461	478	493	510	582	601	618	636	654	670	689	707	839	860	880								
	1	224	242	260	277	294	312	330	347	365	383	399	417	435	453	471	489	507	523	541	559	634	654	672	691	711	731	750	770	905	927	949								
	2	259	279	300	321	342	364	385	406	426	447	468	490	511	532	553	573	594	616	637	658	735	759	782	805	828	850	873	896	1034	1059	1084								
	3	282	304	328	351	374	397	422	445	468	492	515	538	561	585	608	632	656	679	702	725	806	831	856	881	907	932	957	982	1122	1150	1178								
4	308	333	360	386	411	437	464	489	515	541	566	593	618	644	670	697	723	749	774	801	884	911	940	968	995	1023	1050	1078	1221	1251	1283									
230	S	193	208	222	237	250	266	280	294	309	324	339	352	367	382	396	411	425	439	455	469	540	557	573	590	606	623	639	656	786	806	825								
	0	212	227	243	260	276	292	309	325	341	357	373	390	407	423	439	455	471	488	504	520	594	612	630	648	666	684	703	721	854	875	896								
	1	228	246	265	283	301	319	338	355	372	391	409	428	445	464	481	499	517	536	554	572	647	666	686	707	727	747	766	786	921	944	966								
	2	264	286	307	328	350	372	393	415	437	458	480	502	522	544	566	587	609	632	654	675	753	776	801	824	848	871	894	918	1056	1082	1108								
	3	288	312	336	361	385	409	433	457	480	504	529	553	577	601	625	649	674	698	721	745	826	852	877	903	930	955	981	1006	1148	1176	1205								
4	315	342	369	395	422	449	475	502	530	556	583	609	636	663	689	716	743	770	796	824	907	935	964	1021	1050	993	1079	1107	1250	1283	1314									
240	S	196	212	225	241	255	270	285	300	314	330	344	360	373	389	404	418	433	448	462	478	550	566	583	600	616	633	650	666	798	816	836								
	0	215	230	248	265	282	298	314	331	348	365	382	397	414	432	448	465	481	497	514	532	605	624	642	660	679	698	716	734	869	889	910								
	1	234	251	270	289	307	325	344	363	382	399	418	436	455	473	492	511	530	548	565	584	660	681	701	722	741	762	782	803	937	960	984								
	2	270	292	314	336	359	382	404	425	447	469	492	514	536	558	581	603	625	647	668	691	771	795	819	844	868	890	914	938	1078	1104	1131								
	3	296	320	345	369	394	418	444	468	493	517	542	566	592	616	641	665	690	714	740	764	847	873	899	926	953	979	1005	1032	1173	1203	1233								
4	323	350	377	406	433	461	489	516	543	571	599	626	654	681	708	735	763	790	818	846	931	959	990	1019	1048	1077	1106	1137	1281	1313	1344									
250	S	199	215	229	245	260	275	290	306	320	335	350	366	382	395	411	426	441	456	471	487	559	576	593	609	627	643	661	678	809	829	849								
	0	219	236	252	269	287	303	321	338	355	371	389	406	423	439	457	473	491	508	525	541	616	635	654	674	691	710	729	748	881	903	926								
	1	238	256	276	294	313	332	351	370	389	408	428	446	465	483	503	521	540	559	579	597	674	693	714	735	756	777	798	819	955	978	1002								
	2	276	299	321	344	367	390	412	435	458	481	503	527	550	572	594	617	640	663	685	708	788	812	837	861	887	911	935	960	1100	1127	1154								
	3	302	327	352	377	404	429	455	480	506	531	556	581	606	632	658	683	708	733	759	784	867	894	921	949	976	1002	1029	1057	1200	1229	1259								
4	331	360	388	416	445	472	501	530	558	585	614	642	670	700	727	755	784	812	839	869	954	984	1015	1044	1075	1104	1136	1165	1311	1343	1376									
260	S	202	218	234	248	264	279	294	311	326	342	357	372	388	404	418	434	449	465	480	551	567	585	603	619	637	655	670	688	822	840	860								
	0	222	240	258	275	292	310	326	344	362	380	396	414	431	448	466	483	501	518	536	608	627	647	665	685	704	724	742	762	896	918	940								
	1	242	262	282	300	320	340	359	377	397	416	436	455	474	494	513	533	553	571	591	665	686	708	729	750	772	792	813	835	972	996	1020								
	2	282	306	328	351	374	398	422	445	469	492	515	538	562	585	608	632	656	679	702	781	806	831	856	881	907	931	95												

DOPLĄTY DO PROFILU NOŚNEGO I KASETY

(cena z tabeli podstawowej + dopłata)

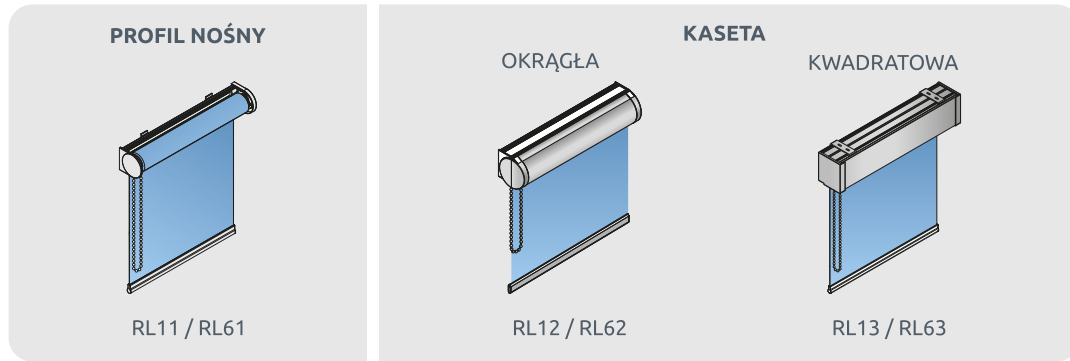

SZEROKOŚĆ

	100	110	120	130	140	150	160	170	180	190	200	210	220	230	240	250	260	270	280	290	300	310	320	330	340	350	360	370	380	390	400
PROFIL NOŚNY	73	78	84	91	97	102	108	115	120	126	132	138	144	150	156	162	168	174	179	186	192	198	203	209	216	221	227	234	239	245	250
KASETA	210	228	245	263	280	298	315	333	350	368	386	402	419	437	455	472	490	508	525	542	560	577	595	612	629	647	664	682	700	717	734

OPCJE DODATKOWE

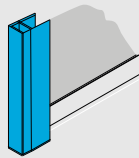

Profile boczne LARGE
ze szczotką uszczelniającą
(kpl. P+L).

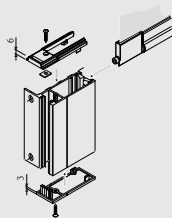

Montaż we wnęce.

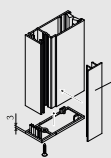

Montaż poza wnęką.

	PROFILE BOCZNE
130	240
140	254
150	269
160	285
170	299
180	314
190	330
200	344
210	360
220	374
230	389
240	405
250	418
260	434
270	448
280	464
290	479
300	494
310	509
320	523
330	538
340	554
350	569
360	583
370	599
380	613
390	628
400	643

	PROFILE PROW. BOCZNEGO
130	89
140	94
150	99
160	104
170	109
180	116
190	120
200	125
210	131
220	137
230	141
240	146
250	152
260	157
270	163
280	168
290	173
300	178
310	184
320	189
330	195
340	200
350	204
360	210
370	216
380	221
390	225
400	230

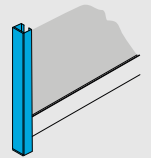

Profile prowadzenia boczne
(kpl. P+L).

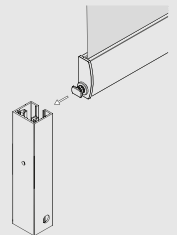

RL-ROLETY LARGE

OPCJE DODATKOWE

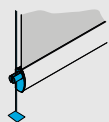

Prowadzenie boczne
(linka boczna + mocowanie
dolne standard + kątownik
stalowy)

67,00 € /kpl.



Łańcuszek metalowy
ze spinką / bezkońcowy

7,40 € /mb
łańcuszka obsługowego**



Łańcuszek bezkońcowy
PVC

3,10 € /szt.

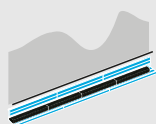

Profil dolny zamykający
ze szczotką uszczelniającą.

30,50 € /mb.

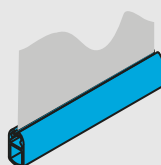

Obciążnik „SLIM”
dostępny w kolorach
systemowych

opcja alternatywna
BEZ DOPLATY

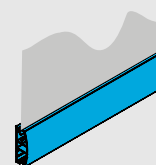

Obciążnik „MEDIUM+”

opcja alternatywna
BEZ DOPLATY

ELEMENTY DODATKOWE

index 2181



Łańcuszek metalowy
***4,45 € /mb.**

index 2179



Łańcuszek PVC
***2,10 € /mb.**



Spinka łańcuszka (metal.)
***0,75 € /szt.**

2182



Spinka łańcuszka (PVC)
***0,55 € /szt.**

2180

** długość łańcuszka obsługowego -> (0,75 x wysokość zamówieniowa rolety) x2

* Cena zakupu samego łańcuszka lub spinki.

index 1234

Elementy dodatkowe zostały oznaczone indeksami, z których można korzystać podczas składania zamówień. Zamiast podawania pełnej nazwy elementu wystarczy posłużyć się przypisanym numerem indeksu.



Ważne

Szczegółowe informacje dotyczące wymiarów kaset, komponentów oraz konstrukcji systemów roletowych, znajdziesz w folderze produktowym. Folder dostępny jest również w wersji elektronicznej na naszej stronie internetowej.



www.shadow-system.pl



Tabela podstawowa i dopłaty

Tabela podstawowa dla modelu:
RSM-10S (S. 31-32)

Dopłaty do profilu nośnego, kasety i sprężyny „SLOW”:
RSM-11S, RSM1-13S (S. 33)

Dopłaty do napędów elektrycznych dla modeli:
RSM-60S, RSM-61S, RSM-63S (S. 56-65).



Informacje

- 1 Do kalkulacji przyjmuje się całkowite wymiary zewnętrzne rolety wraz z kapkami bocznymi.
- 2 Roletę montujemy do ściany, sufitu lub we wnęce okiennej za pomocą wsporników lub kątowników. W zestawie z gotową roletą otrzymasz komplet elementów standardowych niezbędnych do montażu danego modelu. Informacje odnośnie standardowych uchwytów montażowych do poszczególnych modeli rolet znajdziesz w naszym folderze produktowym.
- 3 Maksymalne szerokości tkanin roletowych podane są na stronach katalogowych poszczególnych kolekcji. W przypadku rolet o wymiarach zamówieniowych przekraczających te wartości, roleta może wymagać poziomego łączenia tkaniny (za dopłatą).



Kolory systemu SMART S

Rolety na wspornikach i profilu nośnym



BIAŁY



STARA BIEL



SREBRNY ALUMINIUM



ANTRACYT



CZARNY

Rolety w kasie kwadratowej



BIAŁY



CZARNY



SREBRNY ALUMINIUM

Zestaw dekoracyjny* (metalowe kapki boczne, łańcuszek)



STAL NIERDZEWNA



NATURALNE ALUMINIUM



CZARNY NIKLOWANY



STARY MOSIĄDZ

* do rolet na wspornikach i profilu nośnym

ROLETY WOLNOWISZĄCE
COULISSE ABSOLUTERSM-ROLETY
SMART STABELA
PODSTAWOWA

Podane ceny są cenami netto. Należy doliczyć VAT (23%)

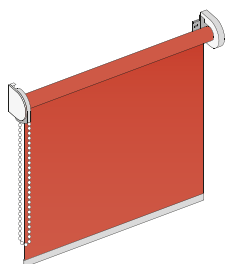

Maksymalna zalecana szerokość*: 250 cm

Maksymalna zalecana wysokość*: 250 cm

Wersje obsługowe*: łańcuszek, napęd elektryczny,
uchwyt.Mocowanie: ściana, sufit, skrzydło okienne,
wnęka okienna.

Rury nawojowe: Ø 28 mm, Ø 30 mm, Ø 35 mm

Długość obsługi: 75% wysokości całkowitej rolety.

		SZEROKOŚĆ															
PG		100	110	120	130	140	150	160	170	180	190	200	210	220	230	240	250
100	S	95	101	107	112	118	123	129	149	156	162	168	175	194	201	208	216
	0	108	115	122	129	137	143	150	172	179	186	194	203	223	232	239	248
	1	116	124	132	140	147	155	163	185	194	202	210	219	240	250	258	269
	2	133	143	153	162	171	181	191	214	225	234	244	256	278	290	300	311
	3	152	164	176	187	198	210	221	247	259	270	283	295	320	333	345	359
110	S	97	103	109	115	121	126	132	153	159	165	172	179	198	206	212	220
	0	111	119	126	133	141	148	155	177	185	192	200	209	229	238	246	256
	1	120	128	137	144	153	161	169	191	200	209	217	227	248	258	267	277
	2	138	149	159	169	179	189	199	223	234	244	255	266	289	301	312	324
	3	159	171	183	195	207	219	232	258	271	283	296	309	334	348	361	375
120	S	99	105	111	117	123	129	135	155	163	169	175	183	202	210	217	225
	0	114	122	129	137	145	152	160	182	190	198	206	215	236	245	254	263
	1	123	132	141	149	158	166	174	197	207	215	225	234	256	266	276	286
	2	143	154	164	175	186	196	207	231	243	254	264	276	300	313	324	336
	3	165	178	191	204	216	229	242	268	282	295	309	323	348	363	377	391
130	S	101	107	114	120	126	132	138	159	166	172	179	187	206	214	222	229
	0	117	125	133	141	149	156	164	187	195	203	211	221	242	251	261	270
	1	126	136	145	153	163	171	180	203	213	222	231	242	264	274	284	295
	2	148	159	171	182	193	203	215	240	251	263	274	287	311	323	336	348
	3	172	185	199	212	225	238	252	280	294	308	321	336	363	377	392	407
140	S	102	109	116	122	129	134	141	162	169	176	183	190	210	218	226	234
	0	120	128	136	145	153	161	169	191	200	209	217	227	248	258	267	277
	1	130	140	149	158	168	176	186	209	219	229	238	249	271	283	293	304
	2	153	165	176	188	200	210	222	248	260	272	284	297	321	335	348	361
	3	178	192	206	221	234	248	262	291	305	320	334	349	377	392	408	423
150	S	104	111	118	124	131	137	144	165	172	179	186	194	214	223	230	239
	0	123	131	140	148	157	165	173	196	206	214	223	233	254	265	274	284
	1	134	144	153	162	173	182	191	215	225	235	246	256	279	290	301	313
	2	158	170	182	194	206	218	230	256	269	281	294	307	332	346	359	373
	3	185	199	214	229	243	258	272	301	317	332	347	363	390	407	423	439
4	211	228	246	263	281	298	315	347	365	382	400	419	449	468	486	506	
PG		100	110	120	130	140	150	160	170	180	190	200	210	220	230	240	250

* w zależności od wybranego modelu rolety i tkaniny.
Szczegółowe informacje w folderze produktowym oraz katalogu tkanin.

Ceny z tabeli powyżej dotyczą modelu w wersji:

łańcuszkowej RSM-10S

Dopłaty do pozostałych modeli znajdziesz na stronie 33.

Dopłaty do **napędów elektrycznych i sterowania** znajdziesz na stronie 58 - 66.

		SZEROKOŚĆ															
PG		100	110	120	130	140	150	160	170	180	190	200	210	220	230	240	250
160	S	106	113	120	127	134	140	147	168	176	183	190	199	218	227	234	243
	0	125	135	143	152	161	169	178	202	211	219	229	239	261	271	281	292
	1	137	148	158	167	177	187	197	221	232	242	253	264	287	299	309	321
	2	163	176	188	200	213	225	238	265	278	291	304	317	343	358	371	385
	3	191	207	222	237	252	267	283	313	328	344	360	377	405	422	438	455
4	219	237	255	273	292	309	328	360	379	397	416	436	467	487	506	526	
170	S	108	115	122	129	136	143	150	171	179	186	194	202	222	231	239	248
	0	128	138	147	156	165	174	183	206	216	225	235	245	267	278	288	299
	1	141	152	162	172	182	192	203	227	239	249	260	271	294	307	318	330
	2	168	181	194	207	220	233	246	273	287	300	313	328	354	369	383	397
	3	197	214	230	246	261	277	293	323	340	356	373	390	419	437	454	472
4	227	246	265	284	303	321	341	374	394	412	432	452	484	505	525	545	
180	S	110	117	125	131	139	146	153	175	182	190	198	206	227	235	243	253
	0	131	141	150	159	169	178	187	211	221	231	240	251	274	285	295	306
	1	144	155	166	176	187	197	209	233	245	256	267	278	303	315	327	339
	2	173	186	200	213	227	240	254	281	296	309	324	338	365	380	395	410
	3	204	221	237	254	271	287	304	335	351	368	385	403	433	451	469	487
4	235	255	275	294	314	333	354	387	408	428	448	469	502	523	544	565	
190	S	111	119	127	134	142	148	156	178	186	194	201	210	230	239	248	257
	0	134	144	154	163	173	182	192	216	227	236	246	257	280	292	302	313
	1	148	159	170	181	192	203	214	239	251	262	274	286	310	323	335	348
	2	177	192	206	220	234	247	261	290	305	319	333	349	375	391	406	422
	3	210	228	245	262	280	296	314	345	363	381	399	417	447	467	485	503
4	243	264	284	305	326	345	366	401	422	443	464	485	519	542	563	585	
200	S	113	121	129	136	144	151	159	181	189	197	205	214	234	244	252	262
	0	137	147	157	167	177	186	197	221	231	241	252	263	286	298	309	321
	1	152	163	174	186	197	208	219	245	257	269	281	293	318	331	343	356
	2	182	197	212	226	240	255	269	298	313	328	343	358	386	403	418	434
	3	216	235	253	270	288	306	324	356	375	393	411	430	461	481	500	520
4	251	272	294	315	336	357	378	414	436	457	480	502	537	560	582	605	
210	S	115	123	131	139	147	154	162	184	192	200	208	218	239	248	257	266
	0	140	151	161	171	181	191	201	226	237	247	258	269	293	305	316	328
	1	155	167	179	190	202	213	225	251	264	276	288	301	326	339	352	365
	2	188	203	218	232	248	262	278	306	322	337	353	369	397	414	430	446
	3	223	242	261	279	297	315	335	367	386	405	424	444	476	496	515	536
4	259	281	303	325	347	369	392	428	451	473	495	519	554	578	601	625	
220	S	117	125	133	141	149	156	165	187	196	204	212	221	242	252	261	271
	0	143	153	164	175	185	195	206	231	242	252	264	276	299	311	323	335
	1	159	171	183	195	207	219	231	257	270	282	295	308	333	347	360	374
	2	192	208	224	239	254	270	285	314	331	346	363	379	408	425	441	459
	3	229	249	268	287	306	325	345	378	398	417	437	458	489	511	531	551
4	267	290	312	336	359	381	404	441	465	488	511	536	572	596	620	645	
230	S	119	128	136	143	152	159	168	190	199	207	216	225	247	256	266	275
	0	146	157	168	178	189	200	210	236	247	258	269	281	306	318	330	342
	1	162	175	187	199	212	224	237	263	276	289	302	316	341	355	369	383
	2	197	213	230	245	261	276	293	323	340	356	372	390	419	436	453	471
	3	236	256	276	295	315	335	355	389	409	429	450	471	504	525	546	568
4	275	299	323	346	370	393	417	455	479	503	527	552	589	614	639	664	
240	S	121	129	138	146	154	162	170	193	203	211	220	229	251	261	270	280
	0	149	160	171	182	193	204	215	241	252	264	275	287	312	325	337	350
	1	165	179	191	204	217	229	242	269	283	296	309	323	349	364	378	392
	2	202	219	236	252	268	284	300	332	349	365	382	400	429	448	465	483
	3	242	263	284	304	324	344	365	400	421	442	463	484	518	540	562	584
4	282	307	332	356	381	405	429	468	494	518	543	569	606	633	659	685	
250	S	122	131	140	148	157	165	173	196	205	214	223	233	255	265	274	284
	0	152	163	174	186	197	208	219	245	257	269	281	293	318	331	344	357
	1	169	182	195	209	222	235	248	275	289	302	316	330	357	371	386	400
	2	207	224	241	258	275	291	308	340	357	374	392	410	440	458	477	496
	3	249	270	291	312	333	354	375	411	432	454	475	498	532	555	577	600
4	290	316	341	366	392	417	442	482	508	533	559	585	624	651	677	704	
PG		100	110	120	130	140	150	160	170	180	190	200	210	220	230	240	250

OPCJE DODATKOWE

 RSM-ROLETY
 SMART S

DOPLĄTY DO PROFILU NOŚNEGO I KASETY

(cena z tabeli podstawowej + dopłata za profil nośny lub kasetę)

PROFIL NOŚNY

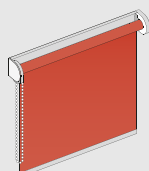

RSM-11S / RSM-61S

PROFIL NOŚNY

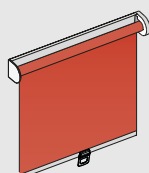

RSM-21S

KASETA KWADRATOWA

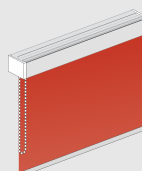

RSM-13S / RSM-63S

SZEROKOŚĆ

	100	110	120	130	140	150	160	170	180	190	200	210	220	230	240	250
PROFIL NOŚNY	21	23	24	26	27	29	30	32	33	35	36	37	39	40	42	43
KASETA	137	146	155	165	174	183	192	202	211	221	230	239	248	258	267	276

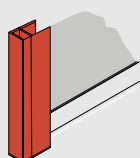

 Profile boczne
 SMART S

NAZWA	PROFILE BOCZNE
100	108
110	117
120	126
130	136
140	145
150	155
160	164
170	173
180	183
190	192
200	201
210	210
220	220
230	229
240	239
250	248

WYSOKOŚĆ

DOPLĄTY DO SPRĘŻYNY „SLOW”

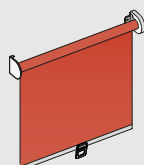
(cena z tabeli podstawowej + dopłata za sprężynę + ewentualna dopłata za profil nośny)



RSM-20S

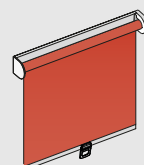

RSM-21S

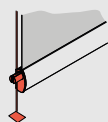
52,00 €

Prowadzenie boczne
 (linka boczna + mocowanie
 dolne standard
 + kątownik stalowy)

85,00 € /kpl.

Zestaw dekoracyjny
 (metalowe kapy boczne
 oraz łańcuszek,
 kolorystyka str. 24)

86,00 € /kpl.

Łańcuszek metalowy
 ze spinką / bezkońcowy

zzgl. 3,10 € /mb
 łańcuszka obsługowego*

RSM-ROLETY SMART S

OPCJE DODATKOWE

<p>index 2181</p>  <p>Łańcuszek metalowy *4,45 € /mb</p>	<p>index 2179</p>  <p>Łańcuszek PVC *2,10 € /mb.</p>	 <p>Łańcuszek bezkońcowy PVC 7,40 € /szt.</p>
 <p>Spinka łańcuszka (metalowa) *0,75 € /szt.</p> <p>2182</p>	 <p>Spinka łańcuszka (PVC) *0,55 € /szt.</p> <p>2180</p>	
 <p>Kątownik profil nośny 5,10 €</p>	 <p>Wspornik 1,60 €</p>	 <p>Kątownik kasetą 4,50 €</p>

* Cena zakupu samego łańcuszka lub spinki.

Wycena krok po kroku



Dane przyjęte do wyceny zostały oznaczone kolorem czerwonym.

Na potrzeby kalkulacji przyjęliśmy następujące parametry:

Wymiary - 135 cm x 119 cm
Model - RSM-21S
Tkanina - S-0884 RO (PG: S)
Dodatki - zestaw dekoracyjny

1. Dokonaj pomiaru, 135 cm x 119 cm (szerokość x wysokość)
2. Z tabeli odczytaj cenę dla zaokrąglonego w górę wymiaru, uwzględniając grupę cenową (PG) wybranej tkaniny, 140 cm x 120 cm (123 €)
3. Wybierz odpowiedni model rolety RSM-21S - cena z tabeli podstawowej + dopłata za profil nośny (27 €) + dopłata do sprężyny „SLOW” (49 €)
4. Dodatkowo wybieramy zestaw dekoracyjny (82 €)
5. Końcowa cena detaliczna (123 € + 27 € + 49 € + 82 €) 281 €



WAŻNE



Do wyceny rolety z napędem elektrycznym konieczne jest dodanie ceny za wybrany silnik elektryczny. Dopłata zawiera montaż napędu w roletcie. Montaż silnika powierzonego jest za dodatkową dopłatą. Ceny dopłat za napędy elektryczne i sterowanie znajdziesz na str. 58 - 66.

SYSTEM SMART M



Ważne

Szczegółowe informacje dotyczące wymiarów kaset, komponentów oraz konstrukcji systemów roletowych, znajdziesz w folderze produktowym. Folder dostępny jest również w wersji elektronicznej na naszej stronie internetowej.



www.shadow-system.pl



Tabela podstawowa i dopłaty

Tabela podstawowa dla modeli:
RSM-10M (S. 36)

Dopłaty do profilu nośnego i kasety dla modeli:
RSM-11M, RSM-13M (S. 39)

Dopłaty do napędów elektrycznych dla modeli:
RSM-60M, RSM-61M, RSM-63M (S. 56 - 65).



Kolory systemu SMART M

Rolety na wspornikach i profilu nośnym



BIAŁY



STARA BIEL



SREBRNY
ALUMINIUM



ANTRACYT



CZARNY

Rolety w kasecie kwadratowej



BIAŁY



CZARNY



SREBRNY
ALUMINIUM



Informacje.

- Do kalkulacji przyjmuje się całkowite wymiary zewnętrzne rolety wraz z kapkami bocznymi.
- Roletę montujemy do ściany, sufitu za pomocą wieszaków (klipsów) lub kątowników. W zestawie z gotową roletą otrzymasz komplet elementów standardowych niezbędnych do montażu danego modelu. Informacje odnośnie standardowych uchwytów montażowych do poszczególnych modeli rolet znajdziesz w naszym folderze produktowym.
- Maksymalne szerokości tkanin roletowych podane są na stronach katalogowych poszczególnych kolekcji. W przypadku rolet o wymiarach zamówieniowych przekraczających te wartości, roleta może wymagać poziomego łączenia tkaniny (za dopłatą).

ROLETY SMART M

RSM - ROLETY SMART M

ROLETY WOLNOWISZĄCE COULISE ABSOLUTE

TABELA PODSTAWOWA

Podane ceny są cenami netto. Należy doliczyć VAT (23%)

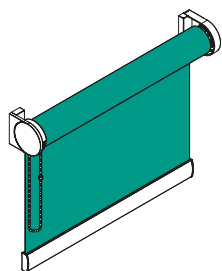

- Maksymalna zalecana szerokość* : 340 cm.
- Maksymalna zalecana wysokość* : 350 cm.
- Wersje obustugowe* : łańcuszek, łańcuszek bezkońcowy, napęd elektryczny.
- Mocowanie : ściana, sufit lub wnęka okienna.
- Rury nawojowe : Ø 38, Ø 42, Ø 50 mm
- Długość obstugi : 75% wysokości całkowitej rolety.

* w zależności od wybranego modelu rolety i tkaniny.

Szczegółowe informacje w folderze produktowym oraz katalogu tkanin.

SZEROKOŚĆ

		SZEROKOŚĆ																																
PG		100	110	120	130	140	150	160	170	180	190	200	210	220	230	240	250	260	270	280	290	300	310	320	330	340								
100	S	120	127	133	140	146	153	159	167	173	180	186	193	200	233	240	249	257	264	316	326	333	344	353	363	371								
	0	133	141	149	158	165	173	180	189	197	205	212	221	229	263	271	282	291	300	352	364	373	384	395	407	416								
	1	141	150	159	168	176	185	193	203	211	220	228	237	246	281	290	302	312	321	375	387	397	409	420	433	443								
	2	158	169	179	190	200	211	221	231	242	253	263	274	284	321	332	345	356	368	423	437	449	462	476	490	502								
	3	177	190	202	215	227	239	251	264	276	289	301	314	326	365	377	392	405	419	477	492	506	522	537	552	566								
110	4	196	210	225	240	253	267	282	296	311	325	339	354	368	408	423	440	455	470	529	547	563	580	597	615	631								
	S	122	129	136	143	149	156	163	170	177	184	190	197	204	238	245	254	262	270	322	331	340	350	360	370	379								
	0	136	145	153	161	169	178	186	194	203	211	218	227	236	270	279	289	299	308	361	373	383	394	405	417	427								
	1	145	154	163	173	181	191	200	209	218	227	236	245	255	290	300	311	321	331	385	398	408	421	432	445	456								
	2	164	174	186	197	207	219	229	240	252	263	273	285	296	333	344	358	370	382	438	451	464	479	492	507	520								
120	3	184	197	210	224	236	249	262	275	288	302	314	327	341	380	393	409	423	437	495	511	526	542	558	574	589								
	4	204	220	235	250	265	280	295	310	325	341	355	371	386	427	443	460	477	492	552	571	587	606	623	642	659								
	S	124	131	138	146	152	159	166	173	180	188	194	202	209	242	250	259	267	275	327	337	346	356	366	377	385								
	0	139	148	156	165	173	182	191	199	208	216	225	234	242	277	286	297	307	316	370	382	392	403	415	427	437								
	1	149	158	168	177	186	196	205	215	224	234	243	253	263	298	309	320	331	341	396	408	419	432	444	458	469								
130	2	168	180	191	203	214	226	237	249	260	272	283	295	307	344	356	370	383	395	452	466	479	494	509	523	537								
	3	190	204	218	232	245	259	273	286	300	314	327	341	355	395	410	425	440	454	513	531	545	562	579	596	611								
	4	213	228	245	260	276	292	308	324	339	356	372	387	404	446	462	481	497	514	575	594	612	630	650	669	686								
	S	126	133	141	149	155	162	169	177	184	191	198	206	213	247	255	264	273	280	333	343	352	363	372	383	392								
	0	142	151	160	170	178	187	195	204	213	222	231	240	249	284	294	305	315	325	378	391	401	413	425	437	448								
140	1	152	162	172	182	192	201	212	221	231	241	251	261	271	307	317	329	341	351	406	420	431	444	456	470	481								
	2	174	186	198	210	222	233	246	258	270	282	294	306	318	356	369	383	396	409	466	481	495	510	525	540	554								
	3	197	212	226	241	254	269	284	298	312	327	341	355	370	410	425	442	458	472	532	550	565	583	600	618	634								
	4	221	237	254	272	288	304	321	338	354	371	387	405	422	464	482	501	519	536	598	618	636	656	676	696	714								
	S	128	136	143	151	158	165	173	180	188	195	203	210	218	251	260	269	278	286	339	349	358	369	379	390	399								
150	0	145	155	164	174	182	191	200	210	219	228	237	247	256	291	301	313	323	333	387	400	410	422	434	447	458								
	1	156	166	176	187	197	207	217	228	238	248	258	269	279	316	326	339	350	361	417	430	441	455	468	482	494								
	2	179	191	204	216	228	241	254	266	279	291	304	317	329	368	381	396	409	423	480	496	510	526	541	557	571								
	3	203	219	234	249	263	279	294	309	324	339	354	369	384	425	441	458	474	490	550	569	585	603	621	640	656								
	4	228	246	264	282	299	317	334	351	369	387	404	422	439	483	501	521	540	558	621	642	660	681	702	723	742								
150	S	130	138	146	153	161	168	176	183	191	200	206	214	222	256	264	274	283	292	344	355	364	375	386	397	406								
	0	149	158	167	177	186	196	205	215	225	234	243	253	263	299	308	320	331	342	396	408	419	432	444	457	469								
	1	159	171	181	192	202	213	223	234	245	255	266	276	287	324	335	348	360	372	427	441	453	467	480	494	506								
	2	183	197	210	223	236	249	262	275	288	301	314	327	341	380	393	409	423	436	495	511	525	542	558	574	589								
	3	210	226	242	258	273	289	304	320	336	352	367	383	399	441	457	475	492	508	569	588	605	624	643	662	679								
4	237	255	273	292	310	329	347	365	384	402	420	439	458	502	521	541	561	580	643	665	685	706	728	749	770									
PG	100	110	120	130	140	150	160	170	180	190	200	210	220	230	240	250	260	270	280	290	300	310	320	330	340									

SZEROKOŚĆ



Ceny z tabeli powyżej dotyczą modelu w wersji:
łańcuszkowej RSM-10M
Dopłaty do pozostałych modeli znajdziesz na stronie 39.



Dopłaty do **napędów elektrycznych i sterowania** znajdziesz na stronie 58 - 66.

SZEROKOŚĆ

PG		100	110	120	130	140	150	160	170	180	190	200	210	220	230	240	250	260	270	280	290	300	310	320	330	340
160	S	132	140	148	156	163	171	179	187	195	203	210	219	227	261	269	279	288	297	350	361	370	381	392	403	413
	0	151	161	171	181	191	200	210	220	230	240	249	260	269	305	316	328	339	349	404	417	428	441	454	467	479
	1	163	174	185	197	207	218	229	240	251	262	273	284	295	332	344	357	369	381	437	451	464	478	492	506	519
	2	189	203	216	230	243	257	270	283	297	311	324	338	351	391	405	421	436	450	509	526	540	557	574	591	606
	3	217	233	250	266	282	299	315	331	347	364	380	397	413	455	473	491	509	526	588	607	625	644	663	683	701
4	245	264	283	303	321	341	360	379	398	417	437	456	475	520	540	562	582	602	666	688	709	731	753	776	797	
170	S	134	142	150	159	166	174	182	191	199	207	215	223	231	265	274	284	294	303	355	367	377	388	398	410	420
	0	155	165	175	185	195	205	215	225	236	246	255	266	276	313	323	336	347	358	413	426	438	451	464	478	490
	1	167	179	190	201	212	224	235	246	258	269	281	292	303	341	353	367	379	391	448	462	475	489	504	519	532
	2	194	208	222	237	250	264	278	292	306	321	334	349	363	403	418	434	449	464	523	540	556	573	590	608	623
	3	224	241	258	275	291	308	326	342	360	377	393	411	428	471	489	508	527	544	606	626	645	665	685	705	724
4	253	273	293	314	333	353	373	393	413	433	453	473	493	539	560	582	603	624	689	712	734	756	780	803	825	
180	S	136	145	153	161	169	177	186	194	202	211	219	227	236	270	279	290	299	308	361	373	382	394	405	417	427
	0	158	168	179	189	199	210	220	231	241	252	261	273	283	320	330	343	355	366	421	435	447	461	474	488	500
	1	171	183	194	206	217	229	241	253	264	277	288	300	312	350	362	376	389	401	458	473	486	501	516	531	544
	2	199	214	228	243	257	272	287	301	315	330	345	359	374	415	430	447	462	478	537	555	571	589	606	624	640
	3	230	248	266	284	301	319	336	354	371	389	407	425	442	486	504	524	543	562	625	646	665	686	706	727	746
4	261	282	303	324	344	365	386	407	428	449	469	490	511	558	579	602	624	646	712	736	758	782	806	830	852	
190	S	138	147	155	164	172	180	189	197	206	215	223	231	240	275	284	295	304	314	367	378	389	400	411	423	434
	0	161	172	182	193	204	215	225	236	247	258	268	279	290	327	338	351	363	375	430	444	456	470	484	498	511
	1	174	187	199	211	223	235	247	259	271	284	295	308	320	358	371	385	399	412	469	484	498	513	528	543	557
	2	204	219	234	250	264	279	294	309	325	340	354	370	385	427	442	460	476	492	552	570	587	605	623	641	658
	3	237	255	273	292	310	329	347	365	384	402	420	438	457	502	521	541	560	580	643	664	684	706	727	749	769
4	269	291	313	335	356	378	399	420	442	464	485	507	529	577	599	623	645	668	735	759	783	807	831	857	880	
200	S	140	149	158	167	174	183	192	201	210	218	227	236	244	279	288	299	309	319	373	385	394	406	418	430	440
	0	164	175	186	197	208	219	230	241	252	263	274	285	296	334	345	359	371	382	439	453	465	479	494	508	521
	1	178	191	203	216	228	240	253	265	278	290	303	315	328	367	380	394	408	421	479	495	508	524	539	555	569
	2	209	225	240	256	271	287	303	318	334	350	365	380	396	438	454	472	489	505	566	585	602	620	639	658	675
	3	243	263	282	300	319	338	357	376	395	414	433	452	471	517	537	557	578	598	661	684	704	726	748	771	791
4	278	300	323	345	367	389	412	434	456	479	502	524	547	595	618	643	666	690	757	783	807	832	858	883	907	
210	S	142	151	160	170	178	187	196	204	213	222	231	240	249	284	293	305	315	324	378	391	401	413	425	437	447
	0	167	179	189	201	212	224	235	246	258	269	280	292	303	341	353	367	379	391	447	462	475	489	503	518	531
	1	182	195	208	221	233	246	259	272	285	298	310	323	336	375	389	404	418	432	489	505	520	536	551	568	582
	2	215	231	246	263	279	295	311	327	343	359	375	392	408	450	467	485	502	519	580	600	617	636	655	675	692
	3	250	270	290	309	329	348	368	387	407	427	446	467	486	532	552	574	595	615	680	703	724	747	769	793	814
4	286	309	332	356	378	402	425	448	472	495	518	541	565	614	638	664	687	712	780	807	831	858	884	910	935	
220	S	144	153	162	172	180	189	199	208	217	226	235	244	253	289	298	310	320	330	384	396	407	419	431	444	454
	0	170	182	193	206	216	228	240	252	263	275	286	299	310	348	360	374	387	399	456	471	484	499	513	528	542
	1	186	199	212	226	238	252	265	278	291	305	318	331	344	384	398	413	428	441	499	516	531	547	563	580	595
	2	219	236	253	270	285	303	319	335	352	369	385	402	419	461	479	498	515	533	594	614	632	652	672	692	710
	3	256	277	297	318	338	358	378	399	419	440	459	480	500	547	568	590	612	633	699	722	744	767	791	814	836
4	294	318	342	366	390	414	438	462	486	510	534	558	582	633	657	684	709	734	803	830	855	883	910	937	962	
230	S	146	156	165	174	183	193	202	211	221	230	239	248	258	293	303	315	325	336	390	402	413	425	437	450	461
	0	173	185	197	209	221	233	245	257	269	281	292	305	317	355	367	382	395	408	464	480	493	509	523	538	552
	1	189	203	216	230	244	257	271	284	298	312	325	339	353	392	407	422	437	451	510	527	542	559	575	592	608
	2	224	242	259	276	293	310	327	344	362	379	395	413	430	473	491	510	529	547	609	629	647	668	688	708	727
	3	263	285	305	326	347	368	389	410	431	452	473	494	515	562	584	607	629	651	717	741	764	788	812	836	859
4	302	327	352	377	401	426	451	476	501	526	550	575	600	652	677	704	730	756	825	854	880	908	936	964	991	
240	S	148	158	167	177	186	195	205	215	224	234	243	253	262	298	308	320	330	340	395	408	419	431	444	456	468
	0	176	188	201	213	225	237	249	262	274	287	299	311	323	362	375	389	403	416	473	489	502	518	533	549	563
	1	193	207	221	235	249	263	277	290	305	319	332	347	360	401	416	431	447	462	520	538	553	570	587	604	620
	2	229	247	265	283	300	317	335	353	371	388	405	423	441	485	503	523	542	560	623	644	663	683	704	725	745
	3	270	291	313	335	356	378	399	421	443	465	486	508	530	577	600	623	647	669	736	760	783	808	833	858	881
4	310	336	362	387	412	438	464	489	515	541	567	593	618	670	696	724	751	777	848	877	904	933	962	990	1018	
250	S	150	160	170	180	189	199	208	218	228	237	247	257	267	303	313	325	336	346	401	414	425	438	4		

SZEROKOŚĆ

PG		100	110	120	130	140	150	160	170	180	190	200	210	220	230	240	250	260	270	280	290	300	310	320	330	340
260	S	152	162	172	182	191	202	212	222	231	242	251	261	271	307	318	330	341	352	406	420	431	444	457	470	482
	0	182	195	208	221	233	246	259	272	285	298	311	324	337	376	389	405	419	432	490	507	521	537	553	569	583
	1	200	215	230	245	259	274	289	303	318	333	347	362	377	418	433	451	466	482	541	559	575	593	611	629	645
	2	240	258	277	296	314	333	351	370	389	408	426	445	464	508	528	548	568	588	651	673	693	715	737	759	779
	3	283	306	329	352	374	398	421	444	467	490	512	536	559	608	632	657	681	705	772	799	823	849	875	902	926
4	326	354	381	408	435	462	490	518	545	572	599	627	654	707	735	765	793	822	894	924	953	984	1014	1044	1073	
270	S	154	165	175	185	195	205	215	225	235	246	255	265	276	312	323	335	346	357	412	426	437	450	463	477	489
	0	185	199	212	225	238	251	264	278	291	305	317	330	344	383	397	412	427	441	499	515	530	547	563	579	594
	1	204	219	234	250	264	279	294	309	325	340	355	370	385	427	442	460	476	492	552	570	587	605	623	641	658
	2	245	264	283	303	321	341	360	379	398	417	436	456	475	520	540	561	582	601	666	688	709	731	753	775	796
	3	290	314	337	361	384	408	431	455	479	503	526	549	573	623	648	673	698	723	791	818	843	870	896	923	949
4	335	363	391	419	447	475	503	531	559	588	615	644	672	727	755	785	815	844	916	948	978	1009	1040	1071	1101	
280	S	156	167	177	188	197	208	218	228	239	249	259	270	280	317	327	340	351	362	418	432	443	456	470	483	496
	0	188	202	215	229	242	256	269	283	296	310	323	337	350	390	404	420	435	449	507	524	539	556	573	589	604
	1	208	224	239	254	269	285	300	316	331	347	362	378	393	435	451	469	485	502	562	580	597	616	635	653	671
	2	250	270	289	309	328	348	368	387	407	427	446	466	486	532	552	574	595	615	680	703	724	747	770	792	814
	3	296	321	345	369	393	417	442	466	491	515	539	564	588	638	663	690	715	740	810	837	863	890	918	945	971
4	342	372	401	430	458	487	516	545	574	603	632	661	690	745	774	806	836	865	939	972	1002	1034	1066	1098	1129	
290	S	158	169	180	191	200	211	221	232	242	253	263	274	285	321	332	345	357	368	424	438	449	463	476	490	502
	0	192	206	219	233	246	261	274	288	302	316	329	344	357	397	411	428	443	457	516	533	549	566	582	599	615
	1	212	228	243	260	275	291	306	323	338	354	369	386	402	443	460	478	495	511	573	592	609	627	647	666	683
	2	255	275	296	316	335	356	376	396	417	437	456	477	497	543	564	587	608	629	694	718	739	762	785	809	831
	3	303	328	353	378	403	428	452	477	503	527	552	578	602	653	679	707	732	758	828	857	883	911	939	967	994
4	351	381	410	440	470	500	529	559	589	618	648	678	708	764	794	826	857	888	962	995	1026	1059	1092	1125	1156	
300	S	160	171	182	193	203	214	224	236	246	257	267	278	289	326	337	350	362	374	429	443	455	469	483	497	509
	0	194	209	223	237	251	265	279	293	307	322	335	350	364	404	419	436	451	466	525	542	558	575	592	610	625
	1	215	232	248	264	279	296	312	329	345	361	377	393	410	452	469	488	505	522	583	602	620	639	659	678	696
	2	260	281	302	323	342	363	384	405	425	447	467	488	508	555	576	599	621	643	709	733	754	778	802	826	848
	3	309	335	361	387	412	438	463	489	514	540	565	591	617	669	695	723	749	776	847	876	902	932	960	989	1016
4	359	390	420	451	480	512	542	573	603	634	664	695	725	782	813	826	878	909	985	1019	1050	1085	1118	1152	1184	
310	S	162	174	185	195	206	217	228	239	250	261	271	282	294	331	342	355	367	379	435	449	462	476	489	504	516
	0	198	212	227	241	255	270	284	298	313	328	341	356	371	412	426	443	459	474	534	551	567	585	602	620	636
	1	219	236	252	269	285	302	318	335	351	368	384	401	418	461	478	497	515	532	593	613	631	651	670	690	709
	2	265	287	308	329	350	371	392	413	435	456	477	498	520	567	589	612	635	657	723	747	770	794	818	843	866
	3	316	343	369	395	421	447	474	500	526	553	579	605	632	684	711	739	767	794	865	895	922	952	981	1010	1039
4	367	399	430	461	492	524	555	586	618	650	680	712	743	801	833	866	899	931	1008	1042	1075	1109	1144	1178	1212	
320	S	164	176	187	198	209	220	231	242	253	264	275	287	298	335	347	360	372	384	441	455	467	482	496	510	523
	0	201	215	230	245	259	274	289	304	318	333	348	363	378	418	434	451	467	482	542	560	576	594	612	630	646
	1	223	240	257	274	290	307	324	341	358	375	392	409	426	469	487	506	524	541	603	624	642	662	682	702	721
	2	270	292	314	336	357	379	401	422	444	465	487	509	531	578	601	625	648	670	737	762	785	810	834	859	883
	3	323	350	377	404	430	457	484	511	538	565	592	619	646	699	727	756	784	811	883	914	942	972	1002	1032	1061
4	375	407	440	472	503	536	568	600	632	665	697	729	761	820	853	887	920	953	1030	1066	1099	1134	1170	1205	1239	
330	S	167	178	189	201	212	223	234	246	257	268	279	291	303	340	352	365	378	390	446	461	474	488	502	517	530
	0	204	219	234	249	264	279	294	309	324	339	354	369	384	426	441	459	475	491	551	569	585	604	622	640	657
	1	226	244	261	279	296	313	330	348	365	382	399	417	434	478	495	515	534	552	614	635	653	674	694	715	734
	2	275	297	320	342	364	386	409	431	453	475	497	520	542	590	613	638	661	684	751	777	800	826	851	876	900
	3	329	357	384	413	440	467	495	522	550	578	605	633	661	714	743	773	801	829	902	933	962	993	1023	1054	1084
4	383	416	449	483	515	548	581	614	647	680	713	746	779	838	872	907	942	975	1053	1090	1124	1160	1196	1232	1267	
340	S	168	180	192	203	214	226	237	249	261	272	284	295	307	344	357	371	383	396	452	467	479	494	509	524	537
	0	207	222	237	254	268	284	299	314	329	345	360	376	391	433	449	466	483	499	559	578	594	613	632	650	667
	1	230	248	266	284	300	318	336	354	372	389	407	425	442	486	504	525	543	562	624	646	664	685	706	727	746
	2	280	303	326	349	371	394	417	440	462	485	507	530	553	602	626	650	674	698	765	792	815	841	867	893	917
	3	336	365	392	421	449	477	505	534	562	591	618	647	675	730	758	789	818	847	921	952	982	1013	1044	1076	1106
4	391	425	459	493	526	560	594	628	662	696	729	763	797	857	891	928	962	997	1076	1113	1148	1185	1222	1259	1294	
350	S	170	183	194	206	217	229	240	252	264	276	287	299	311	349	361	376	388	401	458	472	486	501	515	530	544
	0	210	226	241	257	272	288	303	319	335	351	366	382	398	440	456	474									

OPCJE DODATKOWE

RSM-ROLETY
SMART M

DOPLĄTY DO PROFILU NOŚNEGO I KASAETY

(cena z tabeli podstawowej + dopłata za profil nośny lub kasety)

PROFIL NOŚNY

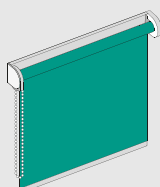

RSM-11M / RSM-61M

KASETA

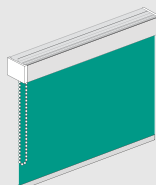

RSM-14M / RSM-64M

SZEROKOŚĆ

	100	110	120	130	140	150	160	170	180	190	200	210	220	230	240	250	260	270	280	290	300	310	320	330	340
PROFIL NOŚNY	36	39	41	44	46	48	51	53	55	57	60	62	65	67	69	71	74	76	78	81	83	86	88	90	92
KASETA	158	169	180	191	202	213	224	234	245	256	267	278	289	300	311	322	333	344	354	365	376	387	398	409	420

Profile boczne
SMART M

	PROFILE BOCZNE
100	135
110	148
120	161
130	174
140	187
150	200
160	213
170	225
180	239
190	251
200	264
210	277
220	290
230	303
240	316
250	329
260	342
270	354
280	368
290	380
300	393
310	406
320	419
330	432
340	445
350	458

WYSOKOŚĆ

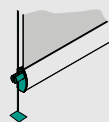

Prowadzenie boczne
(linka boczna + mocowanie
dolne standard
+ kątownik stalowy)

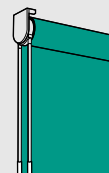
85,00 € /kpl.**Twin Pull****84,00 €**

Łańcuszek metalowy
ze spinką / bezkońcowy

zzgl. 3,10 € /mb.
łańcuszka obsługowego*

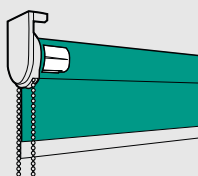
**Mechanizm 1:3****23,00 €**

Łańcuszek bezkońcowy
PVC

7,40 € /szt.**Kątownik profil nośny****2,00 € /szt.****Kątownik kasety****3,50 € /szt.****Wspornik****6,50 € /szt.**

* długość łańcuszka obsługowego -> (0,75 x wysokość zamówieniowa rolety) x2



Ważne

Szczegółowe informacje dotyczące wymiarów kaset, komponentów oraz konstrukcji systemów roletowych, znajdziesz w folderze produktowym. Folder dostępny jest również w wersji elektronicznej na naszej stronie internetowej.



www.shadow-system.pl



Kolory systemu SMART

Rolety na wspornikach i profilu nośnym



BIAŁY



STARA BIEL



SREBRNY
ALUMINIUM



ANTRACYT



CZARNY

Rolety w kasecie kwadratowej



BIAŁY



CZARNY



SREBRNY
ALUMINIUM



Tabela podstawowa i dopłaty

Tabela podstawowa dla modelu:
RSM-10L (S. 41)

Dopłaty do prrofilu nośnego i kasety dla modeli:
RSM-11L, RSM1-13L (S. 44 -45)

Dopłaty do napędów elektrycznych dla modeli:
RSM-60L, RSM-61L, RSM-63L (S. 56 - 65).



Informacje

- 1 Do kalkulacji przyjmuje się całkowite wymiary zewnętrzne rolety wraz z kapkami bocznymi.
- 2 Roletę montujemy do ściany, sufitu lub we wnęce okiennej za pomocą wsporników, wieszaków (klipsów) lub kątowników. W zestawie z gotową roletą otrzymasz komplet elementów standardowych niezbędnych do montażu danego modelu. Informacje odnośnie standardowych uchwytów montażowych do poszczególnych modeli rolet znajdziesz w naszym folderze produktowym.
- 3 Maksymalne szerokości tkanin roletowych podane są na stronach katalogowych poszczególnych kolekcji. W przypadku rolet o wymiarach zamówieniowych przekraczających te wartości, roleta może wymagać poziomego łączenia tkaniny (za dopłatą).

ROLETY SMART L

ROLETY WOLNOWISZĄCE
COULISSE ABSOLUTE

RL-ROLETY
SMART L

TABELA
PODSTAWOWA

Podane ceny są cenami netto. Należy doliczyć VAT (23%)

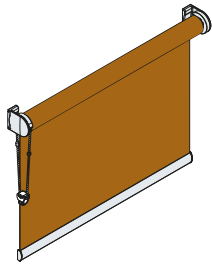

Maksymalna zalecana szerokość* : 430 cm.
 Maksymalna zalecana wysokość* : 430 cm.
 Wersje obsługowe* : łańcuszek, łańcuszek bezkońcowy, napęd elektryczny.
 Mocowanie: ściana, sufit lub wnęka okienna.
 Rury nawojowe: Ø 50 mm, Ø 65 mm, Ø 80 mm
 Długość obsługi: 75% wysokości całkowitej rolety.

* w zależności od wybranego modelu rolety i tkaniny.

Szczegółowe informacje w folderze produktowym oraz katalogu tkanin.

		SZEROKOŚĆ																																		
		PG	100	110	120	130	140	150	160	170	180	190	200	210	220	230	240	250	260	270	280	290	300	310	320	330	340	350	360	370	380	390	400	410	420	430
130	S	182	192	202	212	221	231	240	250	260	270	279	289	299	309	318	328	337	347	357	366	376	386	395	405	415	425	524	536	548	561	571	753	770	786	
	0	198	210	221	233	244	256	266	278	289	301	311	323	334	346	357	369	380	391	402	414	425	436	447	459	470	482	582	596	610	624	636	820	838	856	
	1	208	221	233	246	258	270	282	295	307	320	331	344	356	369	381	393	405	418	430	443	454	467	479	492	504	516	618	632	648	662	676	861	880	898	
	2	230	245	259	274	288	302	317	331	345	360	374	389	403	418	432	447	461	476	490	504	518	533	548	562	576	591	695	712	729	746	762	948	970	990	
	3	254	270	287	304	321	338	354	371	388	405	421	438	455	472	489	506	522	539	556	573	589	606	623	640	657	674	780	799	818	837	856	1045	1069	1091	
4	277	296	315	335	354	373	392	411	430	450	468	488	507	526	545	564	583	603	622	641	660	679	698	717	736	756	864	886	908	929	950	1141	1168	1193		
140	S	185	195	204	215	224	234	244	254	264	274	284	294	303	314	323	333	343	353	363	373	382	393	402	413	422	432	532	544	557	568	580	763	779	796	
	0	202	214	225	237	249	260	272	284	295	306	318	330	342	353	365	377	388	400	411	423	434	446	458	470	481	493	594	608	622	636	650	834	852	870	
	1	212	225	238	251	263	276	288	302	314	327	339	353	365	378	390	403	415	428	441	454	466	479	492	504	517	530	632	647	662	677	692	877	896	915	
	2	235	251	265	280	295	310	325	340	355	370	385	400	415	430	445	460	474	490	504	519	534	550	564	579	594	609	714	731	749	766	783	970	992	1013	
	3	260	278	295	313	330	348	365	383	400	418	435	453	470	488	505	522	540	557	575	592	609	627	645	662	680	697	804	824	844	864	883	1073	1097	1121	
4	285	306	326	345	365	386	405	425	445	465	485	506	525	545	565	585	605	625	645	665	685	705	725	745	765	785	894	917	939	961	983	1176	1202	1229		
150	S	186	197	207	218	227	238	247	258	267	278	288	298	308	319	328	339	348	359	369	379	389	399	409	420	429	440	540	552	565	577	589	772	788	805	
	0	205	218	229	241	253	266	279	289	301	313	324	337	348	361	372	385	396	409	420	432	444	456	468	480	492	504	606	620	635	649	662	847	866	884	
	1	216	230	242	256	269	282	294	308	321	334	347	360	373	387	399	413	425	439	452	465	478	491	504	517	530	544	646	661	677	693	707	893	913	932	
	2	240	257	272	287	303	318	333	349	364	380	395	411	426	442	457	473	488	504	519	535	550	566	581	597	612	628	733	751	769	787	804	992	1014	1036	
	3	267	285	303	322	339	358	375	394	412	431	449	467	485	503	521	540	557	576	593	612	630	648	666	685	702	721	828	849	870	891	910	1101	1126	1150	
4	294	315	335	356	377	398	418	440	460	481	502	523	543	564	585	606	626	648	668	689	710	731	751	772	793	814	924	947	971	994	1016	1210	1237	1264		
160	S	189	200	210	221	231	241	251	261	272	282	292	303	313	324	334	344	354	365	375	386	396	406	416	427	438	447	548	560	574	586	598	781	798	814	
	0	208	221	233	246	258	270	282	295	307	319	331	344	356	368	381	393	405	417	429	442	454	467	479	491	504	516	617	632	647	662	675	861	880	898	
	1	220	234	247	261	275	288	301	315	328	342	355	368	382	396	409	422	435	449	462	476	489	503	516	530	543	557	660	676	692	708	723	909	929	949	
	2	246	262	278	294	310	326	342	358	374	390	406	422	438	455	470	486	502	518	534	551	566	582	598	615	630	646	752	770	789	807	825	1014	1036	1058	
	3	274	293	312	331	350	368	387	406	424	444	462	481	500	519	538	557	575	594	613	632	650	669	688	707	726	745	853	874	896	917	937	1128	1154	1180	
4	302	324	345	367	389	412	432	453	475	497	518	540	562	584	605	627	648	670	692	713	734	756	778	800	822	843	954	978	1003	1026	1050	1244	1272	1300		
170	S	191	202	213	224	234	245	254	265	276	286	297	308	318	329	339	350	360	371	381	392	402	414	423	434	445	456	556	568	582	595	607	790	807	824	
	0	212	225	237	250	263	275	287	300	312	325	338	351	363	376	388	401	413	426	438	451	464	477	489	502	515	527	629	644	659	675	689	874	893	912	
	1	224	239	252	266	280	294	307	321	335	349	363	377	390	405	419	432	446	460	473	487	501	515	529	543	557	571	674	690	707	723	739	925	946	966	
	2	251	268	285	301	317	334	350	367	383	400	416	434	450	467	483	500	515	533	549	565	582	599	615	632	648	665	771	790	809	828	846	1035	1059	1081	
	3	281	301	320	340	359	378	398	417	437	456	476	496	515	535	554	574	593	612	632	651	671	690	710	730	749	769	878	899	922	943	965	1156	1183	1208	
4	310	333	356	378	401	423	445	468	490	512	535	558	580	603	625	648	670	692	714	737	759	782	805	827	850	872	984	1009	1034	1059	1083	1278	1307	1336		
180	S	194	205	215	226	237	248	258	269	280	291	301	312	323	334	344	356	366	377	387	398	409	420	431	442	452	463	564	577	590	603	615	799	817	834	
	0	215	228	241	254	267	280	292	306	318	332	344	358	370	384	396	409	422	435	448	461	474	487	499	513	525	539	641	656	672	687	702	887	907	926	
	1	228	243	257	271	285	299	314	328	342	357	370	385	399	414	428	442	456	470	485	499	513	528	542	556	570	584	688	705	722	738	754	941	962	982	
	2	256	274	291	308	325	342	359	376	393	410	427	444	461	479	496	513	529	546	564	581	597	615	632	650	666	683	790	809	829	848	867	1057	1081	1104	
	3	287	308	328	348	369	389	409	429	449	469	489	510	530	550	570	590	610	631	651	671	691	712	732	752	772	792	902	924	947	970	992	1185	1211	1238	
4	318	342	365	389	412	435	459	482	505	528	551	575	598	622	645	668	691	714	738	762	784	808	831	855	878	902	1014	1040	1066	1091	1116	1312	1342	1372		



Ceny z tabeli powyżej dotyczą modelu w wersji: **łańcuszkowej RL10**
 Dopłaty do pozostałych modeli znajdziesz na stronie 45.



Dopłaty do **napędów elektrycznych i sterowania** znajdziesz na stronach 58 - 66.

SZEROKOŚĆ

PG		100	110	120	130	140	150	160	170	180	190	200	210	220	230	240	250	260	270	280	290	300	310	320	330	340	350	360	370	380	390	400	410	420	430
190	S	195	207	218	229	240	251	262	273	284	295	306	317	328	339	350	361	372	383	394	405	416	427	438	449	460	471	572	584	599	612	624	808	826	843
	0	218	232	245	258	272	285	298	311	324	338	351	364	378	391	404	417	431	444	457	470	483	497	510	524	537	550	653	668	685	700	715	900	921	940
	1	232	247	261	276	291	306	320	334	349	364	378	393	408	423	437	452	466	481	495	510	525	539	554	569	583	598	702	719	737	754	770	957	978	999
	2	261	279	297	315	332	350	367	385	402	420	437	456	473	491	508	526	543	561	578	596	614	631	649	667	684	702	809	829	850	869	888	1078	1103	1127
	3	294	315	336	357	378	399	419	440	461	482	503	524	545	566	587	608	628	649	670	691	711	732	753	775	795	816	927	950	973	996	1019	1212	1240	1267
200	S	221	235	248	263	276	290	303	317	330	344	357	371	384	398	411	426	438	452	466	480	493	507	520	534	548	561	664	680	697	712	728	914	934	954
	0	236	251	266	281	296	311	326	341	356	371	386	401	416	431	446	461	476	491	506	521	536	551	566	581	596	611	716	733	751	768	786	973	995	1016
	1	267	285	303	321	339	358	375	393	412	430	448	466	485	503	521	539	557	575	593	611	629	648	666	684	702	720	828	848	869	889	909	1100	1125	1149
	2	301	323	344	366	387	409	430	452	473	495	516	538	560	581	603	624	645	668	689	710	732	753	775	797	818	840	951	974	999	1023	1046	1240	1268	1296
	3	335	360	385	410	435	460	485	510	534	560	585	610	635	660	685	710	734	759	784	810	834	860	884	909	934	959	1074	1101	1129	1156	1183	1380	1412	1443
210	S	200	212	223	235	246	258	269	280	291	303	314	326	338	349	360	372	383	395	406	418	429	441	452	464	475	486	587	601	616	629	642	826	844	862
	0	225	239	252	267	281	295	308	322	336	350	363	378	392	406	420	434	447	462	475	489	503	517	531	545	559	573	676	692	709	726	741	927	948	968
	1	240	256	271	286	302	317	332	348	363	379	394	410	425	440	456	471	486	502	517	533	548	564	579	594	610	626	730	748	766	784	801	989	1011	1032
	2	272	291	309	328	347	366	384	403	421	440	459	478	496	515	534	552	570	590	608	627	645	664	683	702	720	739	847	868	890	910	930	1122	1147	1172
	3	308	330	353	375	397	419	441	464	486	508	530	553	575	597	619	642	663	686	708	730	752	775	797	819	842	864	975	1000	1025	1050	1073	1268	1297	1325
220	S	202	214	226	237	249	261	272	284	296	308	319	331	342	354	366	378	389	401	412	424	435	447	459	471	483	494	596	610	624	638	651	835	854	872
	0	228	242	257	271	285	299	313	328	342	356	370	385	399	413	428	442	456	470	484	499	513	527	541	556	570	584	688	705	722	738	754	941	962	982
	1	244	260	276	291	307	323	338	354	370	386	402	418	434	449	465	481	497	512	528	544	560	576	591	607	623	639	744	763	781	799	817	1005	1027	1049
	2	282	303	325	347	369	391	413	435	457	479	501	523	545	567	589	611	633	655	677	699	721	743	765	787	809	831	942	966	990	1014	1038	1133	1169	1195
	3	314	338	361	384	407	429	452	475	498	521	543	567	590	613	636	658	681	704	727	750	773	796	819	842	864	887	1000	1025	1051	1076	1100	1296	1326	1355
230	S	204	217	228	240	252	264	276	288	300	312	323	335	347	359	371	383	395	407	419	431	442	454	466	478	490	502	603	617	632	646	660	844	863	881
	0	231	246	260	275	290	305	318	333	348	363	377	392	406	421	435	450	464	479	493	508	522	537	552	566	581	596	700	717	734	751	767	954	975	996
	1	247	264	280	296	313	329	345	361	377	393	409	426	442	458	474	491	506	523	539	555	571	588	604	620	636	653	758	777	796	814	832	1021	1044	1066
	2	282	303	322	342	362	381	401	421	441	461	481	500	519	539	559	579	598	618	638	657	677	697	716	736	756	776	885	907	930	952	973	1165	1192	1217
	3	321	345	369	392	416	440	463	487	510	534	557	581	605	628	652	675	699	723	746	770	793	817	840	864	888	911	1025	1050	1077	1103	1128	1324	1354	1384
240	S	207	219	231	243	255	267	279	292	304	316	328	341	352	365	376	389	401	413	425	437	449	461	473	485	498	510	612	626	641	655	669	853	872	890
	0	234	250	266	284	299	314	329	344	359	375	390	405	420	436	451	467	481	497	511	527	542	558	572	588	603	619	723	741	759	777	794	981	1003	1024
	1	251	269	285	302	318	335	351	368	384	401	417	434	450	467	484	500	517	534	550	567	583	600	617	633	650	666	773	791	811	829	848	1037	1060	1083
	2	288	309	329	349	369	389	409	430	450	470	490	511	531	552	572	592	612	632	653	673	693	713	733	754	774	794	904	926	949	972	994	1187	1214	1240
	3	328	353	377	401	425	450	474	498	522	547	571	596	620	644	668	692	717	741	765	789	813	838	862	887	911	935	1049	1076	1103	1129	1155	1351	1383	1413
250	S	209	222	234	246	258	271	282	295	307	320	332	345	357	370	381	394	406	419	431	443	455	468	480	493	505	619	619	634	649	664	848	868	888	900
	0	238	254	268	284	299	314	329	344	359	375	390	405	420	436	451	467	481	497	511	527	542	558	572	588	603	619	723	741	759	777	794	981	1003	1024
	1	255	273	289	307	323	341	357	374	391	408	425	442	459	476	493	510	527	544	561	578	595	612	629	646	663	680	786	806	826	845	864	1053	1076	1100
	2	293	314	335	356	377	398	417	439	459	480	501	522	542	563	584	605	625	647	667	688	709	730	750	771	792	813	923	946	970	993	1015	1208	1236	1263
	3	335	360	385	410	435	460	485	510	534	560	584	610	634	660	684	710	734	759	784	809	834	859	884	909	934	959	1073	1100	1128	1155	1182	1380	1411	1442
260	S	211	224	236	249	261	274	286	299	312	324	336	349	362	375	387	400	412	425	437	450	462	475	487	500	513	525	627	642	658	672	686	871	891	910
	0	241	257	272	288	303	319	334	350	365	381	396	412	428	443	459	474	489	505	521	537	552	567	583	599	614	630	735	753	771	789	806	994	1016	1038
	1	259	277	294	312	329	346	363	381	398	416	433	450	468	485	503	520	537	555	572	590	606	624	641	659	676	693	800	820	840	860	879	1069	1093	1117
	2	299	320	341	363	384	405	426	448	469	491	512	533	554	576	597	618	639	661	682	704	724	746	767	789	810	831	942	965	990	1014	1036	1230	1258	1286
	3	342	368	393	419	444	470	495	521	547	573	598	624	650	675	701	726	752	777	803	829	854	880	906	932	957	983	1098	1126	1154	1182	1209	1407	1440	1472
270	S	213	227	239	252	265	278	290	303	315	329	341	354	367	380	392	405	417	431	443	456	469	482	494	507	520	533	635	650	666					

		SZEROKOŚĆ																																										
PG		100	110	120	130	140	150	160	170	180	190	200	210	220	230	240	250	260	270	280	290	300	310	320	330	340	350	360	370	380	390	400	410	420	430									
290	S	218	231	245	258	271	284	297	310	323	337	350	363	377	390	403	416	429	443	456	469	482	496	509	522	535	549	651	667	683	699	713	898	919	938									
	0	251	268	284	301	317	334	350	366	383	400	416	433	449	466	482	499	515	532	548	565	581	598	615	631	647	665	771	789	808	827	846	1034	1058	1081									
	1	271	290	308	327	345	364	382	401	419	438	456	475	494	512	531	549	567	586	605	623	642	660	679	698	716	735	843	863	885	906	926	1117	1142	1167									
	2	314	338	360	384	406	429	452	475	498	521	543	566	589	612	635	658	681	704	726	749	772	795	818	841	864	887	999	1024	1050	1075	1100	1295	1325	1354									
	3	362	390	418	446	473	501	528	556	584	611	639	667	694	722	750	778	805	833	860	888	915	943	971	999	1026	1054	1172	1201	1232	1262	1291	1491	1526	1560									
4	410	443	475	508	540	573	605	637	670	702	734	767	800	833	864	897	929	962	994	1027	1059	1092	1124	1157	1189	1222	1344	1378	1414	1449	1482	1687	1727	1765										
300	S	220	234	247	260	274	287	300	314	327	341	354	368	381	395	408	422	435	449	462	475	488	502	515	529	543	556	659	675	691	706	722	908	928	947									
	0	254	271	288	305	321	339	355	372	389	406	422	440	456	473	490	507	524	540	557	574	591	608	625	642	659	675	782	801	821	840	859	1048	1071	1094									
	1	275	294	313	332	350	369	388	407	426	445	464	483	502	521	540	559	578	596	615	634	653	672	691	710	729	748	857	878	899	921	941	1132	1158	1183									
	2	320	343	366	390	413	437	460	483	507	531	554	577	600	624	647	671	694	717	741	765	788	811	834	858	881	1018	905	1044	1070	1096	1121	1316	1346	1376									
	3	369	398	426	454	483	511	539	567	596	624	652	681	709	738	766	794	822	851	879	908	936	965	992	1021	1049	1078	1196	1226	1258	1288	1318	1519	1554	1588									
4	418	452	485	519	551	585	619	651	684	718	751	785	818	851	884	918	951	984	1017	1051	1084	1118	1151	1184	1217	1250	1373	1409	1445	1480	1515	1721	1761	1801										
310	S	222	236	250	263	277	291	304	318	332	345	359	373	386	400	414	428	441	455	468	482	495	509	522	537	550	564	667	683	700	715	731	917	937	957									
	0	257	275	292	309	326	344	360	378	395	412	429	447	464	481	498	515	532	550	567	584	601	618	636	653	670	687	794	813	833	853	872	1061	1085	1108									
	1	279	299	318	337	356	376	395	414	433	453	472	492	511	530	549	569	588	607	626	646	665	685	704	723	743	762	870	892	914	936	957	1149	1175	1200									
	2	325	350	373	397	421	445	468	493	516	540	564	589	612	636	660	684	708	732	756	780	803	828	852	876	900	924	1037	1063	1090	1116	1142	1338	1369	1399									
	3	376	405	434	463	492	521	550	579	608	637	666	695	724	753	782	812	840	869	898	927	956	986	1014	1043	1073	1102	1220	1252	1283	1314	1345	1547	1583	1618									
4	427	461	495	529	564	598	631	666	700	734	768	802	836	870	905	939	972	1007	1041	1075	1109	1143	1177	1211	1246	1280	1404	1440	1477	1513	1549	1756	1796	1837										
320	S	224	239	252	266	280	294	308	322	335	350	363	377	391	405	419	433	446	461	474	489	502	516	530	544	558	572	675	692	708	724	740	926	947	967									
	0	261	278	296	314	331	348	365	384	401	418	435	453	471	488	506	524	540	558	576	594	611	628	646	663	681	698	806	826	845	865	885	1075	1099	1122									
	1	283	303	323	342	362	381	401	421	440	460	480	500	519	539	559	578	598	618	637	657	677	697	716	736	756	775	885	909	929	951	973	1165	1191	1217									
	2	330	355	380	404	428	453	477	502	526	551	575	599	624	648	673	698	722	746	770	795	819	844	869	893	917	942	1056	1083	1110	1137	1163	1360	1391	1422									
	3	383	413	443	472	502	531	561	591	620	650	680	710	739	769	799	828	858	888	917	947	977	1007	1036	1066	1095	1125	1245	1277	1309	1341	1372	1575	1611	1647									
4	435	470	505	540	575	610	645	680	714	750	785	820	855	890	925	960	994	1029	1064	1099	1134	1169	1204	1239	1274	1309	1433	1471	1508	1546	1582	1789	1831	1873										
330	S	227	241	255	269	283	298	311	326	339	354	368	382	396	410	424	438	452	467	480	495	509	523	537	551	565	579	683	700	716	733	748	935	956	976									
	0	264	282	299	318	335	354	371	389	407	425	442	460	478	496	513	532	549	567	585	603	620	639	656	674	692	710	818	837	858	878	898	1087	1112	1136									
	1	286	307	327	347	367	387	407	428	447	468	487	508	528	548	568	588	608	629	648	669	688	709	729	749	769	789	899	921	944	966	988	1180	1208	1234									
	2	335	360	386	411	436	461	486	511	536	561	585	611	635	660	686	711	735	761	786	811	835	861	885	911	935	961	1075	1102	1130	1158	1184	1381	1413	1445									
	3	389	420	450	481	511	542	572	602	632	663	693	724	754	785	815	846	876	906	936	967	997	1028	1058	1088	1119	1149	1269	1302	1335	1368	1400	1602	1640	1676									
4	443	479	515	551	587	623	658	694	730	766	801	837	873	909	944	980	1016	1052	1087	1124	1158	1195	1230	1266	1302	1338	1464	1501	1540	1578	1615	1823	1866	1908										
340	S	229	244	258	272	286	300	315	329	344	358	372	387	401	415	429	444	458	473	486	501	515	530	544	559	573	587	691	708	725	741	757	944	965	986									
	0	267	286	303	322	340	358	376	395	412	431	449	467	485	503	522	540	558	576	594	612	630	649	667	685	703	721	829	850	871	891	911	1101	1126	1150									
	1	290	311	332	352	372	393	413	434	455	475	495	516	536	557	577	598	618	639	659	680	700	721	741	762	782	803	913	935	959	982	1004	1197	1224	1251									
	2	341	367	392	417	443	468	494	520	545	571	596	622	647	673	698	724	749	775	800	826	851	877	902	928	953	979	1094	1122	1150	1178	1205	1403	1435	1467									
	3	396	428	458	490	521	552	582	614	645	676	707	738	769	800	831	862	893	924	955	986	1017	1049	1080	1111	1142	1173	1294	1327	1361	1394	1427	1630	1668	1706									
4	452	489	525	562	598	635	671	708	744	781	818	855	891	928	964	1001	1037	1074	1110	1147	1184	1221	1257	1294	1330	1367	1493	1532	1571	1611	1649	1858	1901	1944										
350	S	231	246	260	275	289	304	318	333	347	362	376	391	405	420	434	450	463	479	493	507	522	537	551	566	580	595	699	716	733	750	766	953	974	995									
	0	270	289	307	326	344	363	381	400	418	437	455	474	492	511	530	548	566	585	603	622	640	659	677	696	714	733	841	862	883	904	924	1114	1140	1165									
	1	294	316	336	357	378	399	419	441	461	483	503	524	545	566	587	608	628	650	670	691	712	733	753	775	795	817	927	950	974	997	1019	1213	1240	1268									
	2	346	372	398	425	450	477	502	528	554	581	607	633	659	685	711	737	762	789	815	841	867	893	919	945	971	998	1113	1141	1170	1198	1226	1425	1457	1490									
	3	403	435	467	499	530	562	593	625	657	689	720	753	784	816	847	879	911	943	974	1007	1038	1070	1101	1133	1165	1197	1318	1352	1387	1421													

		SZEROKOŚĆ																																	
PG		100	110	120	130	140	150	160	170	180	190	200	210	220	230	240	250	260	270	280	290	300	310	320	330	340	350	360	370	380	390	400	410	420	430
390	S	240	256	271	287	302	317	332	348	363	379	394	410	425	441	456	472	487	502	518	533	548	564	579	595	610	626	731	748	767	784	802	990	1012	1034
	0	284	303	323	343	363	383	402	422	442	462	481	501	521	541	560	581	600	620	640	660	679	699	719	739	758	779	888	910	932	955	977	1168	1195	1221
	1	310	333	355	378	400	423	444	467	489	512	534	557	579	602	624	647	669	691	714	737	759	781	804	827	848	871	983	1008	1033	1058	1082	1276	1306	1334
	2	367	396	424	452	480	509	536	564	593	621	649	677	705	734	762	790	818	846	874	903	930	959	987	1016	1043	1072	1190	1220	1251	1281	1311	1512	1547	1581
	3	430	465	499	534	568	603	637	671	706	741	775	809	844	879	913	948	981	1016	1050	1085	1119	1154	1189	1223	1257	1292	1416	1453	1490	1527	1563	1770	1811	1852
4	493	534	575	616	656	698	738	779	819	860	901	942	983	1023	1064	1105	1146	1186	1227	1268	1308	1349	1391	1431	1472	1513	1643	1686	1729	1773	1815	2028	2076	2123	
400	S	242	258	273	290	305	321	336	351	367	383	398	414	430	446	461	477	492	508	524	540	555	571	586	602	618	633	739	757	775	793	811	998	1021	1043
	0	287	307	327	347	367	387	407	428	447	468	488	508	528	548	569	589	608	629	649	669	689	709	729	750	770	790	900	922	945	967	989	1181	1208	1234
	1	314	337	359	383	405	428	450	474	496	519	542	565	588	611	633	656	679	702	725	747	770	793	816	839	862	884	997	1022	1048	1073	1097	1292	1322	1351
	2	372	401	430	459	487	516	544	573	602	630	659	688	717	746	774	803	831	860	888	917	946	975	1004	1032	1061	1090	1208	1239	1271	1302	1332	1533	1568	1603
	3	437	473	507	543	578	613	647	683	718	753	788	824	859	894	929	965	999	1035	1069	1104	1140	1175	1210	1245	1280	1316	1440	1478	1516	1554	1590	1798	1839	1881
4	501	543	585	627	668	710	751	793	834	876	917	959	1001	1042	1084	1126	1167	1209	1250	1292	1333	1375	1416	1458	1500	1542	1673	1717	1761	1805	1848	2062	2111	2158	
410	S	244	261	276	292	308	324	339	356	371	387	403	419	435	451	467	483	498	514	530	546	562	578	593	609	626	641	747	765	784	802	819	1008	1030	1052
	0	290	311	331	351	372	393	412	433	453	474	494	515	535	556	577	597	617	638	658	678	699	720	740	760	781	801	911	934	957	980	1002	1195	1222	1249
	1	318	342	364	387	411	434	457	480	503	527	550	573	597	620	643	666	689	713	735	759	782	806	828	852	875	899	1011	1037	1063	1088	1113	1309	1339	1368
	2	378	407	436	465	495	524	553	582	611	641	670	699	728	758	787	816	845	875	904	933	962	992	1021	1050	1079	1109	1227	1259	1291	1322	1353	1555	1591	1626
	3	444	480	516	551	588	623	659	695	731	766	802	839	874	910	945	982	1017	1053	1089	1125	1160	1197	1232	1268	1304	1340	1465	1503	1542	1580	1617	1825	1868	1910
4	510	553	595	637	680	723	764	807	849	892	934	977	1019	1062	1104	1147	1188	1232	1274	1316	1358	1401	1443	1486	1529	1571	1703	1748	1793	1837	1882	2097	2146	2194	
420	S	246	263	279	295	311	327	343	360	375	392	407	424	440	456	472	488	504	521	536	552	568	585	600	617	633	649	755	773	792	810	828	1017	1040	1062
	0	293	314	335	356	377	397	417	439	459	480	501	522	543	563	584	605	625	647	667	688	708	729	750	771	792	813	923	946	970	993	1015	1208	1236	1262
	1	322	346	369	393	416	440	463	487	510	534	558	582	605	629	653	676	699	723	746	770	794	818	841	865	888	912	1025	1051	1078	1104	1128	1324	1355	1385
	2	383	413	443	473	502	532	561	591	621	651	680	711	740	770	800	830	859	889	918	948	978	1008	1037	1067	1097	1127	1246	1278	1310	1343	1374	1576	1613	1649
	3	450	488	524	560	597	633	669	707	743	779	816	852	889	926	962	998	1034	1071	1107	1144	1181	1217	1254	1290	1327	1363	1490	1528	1567	1606	1644	1853	1897	1940
4	518	562	605	648	692	735	778	821	864	908	951	995	1038	1081	1124	1167	1210	1254	1297	1340	1383	1427	1470	1514	1557	1600	1733	1778	1824	1870	1915	2130	2181	2230	
430	S	249	266	281	298	314	331	347	363	379	396	412	428	445	461	477	494	510	527	542	559	575	591	608	624	640	657	763	781	801	819	837	1026	1049	1072
	0	296	318	339	360	381	402	423	444	465	487	507	528	550	571	592	613	634	655	677	698	718	740	761	782	803	824	935	958	982	1006	1028	1221	1249	1277
	1	325	350	374	398	422	446	470	494	518	542	565	590	614	638	662	686	709	734	758	782	805	829	854	878	902	926	1039	1066	1092	1119	1144	1340	1371	1402
	2	388	419	449	479	510	540	570	600	631	661	691	722	752	782	812	843	872	903	933	964	993	1024	1054	1085	1115	1146	1265	1298	1331	1363	1395	1598	1635	1672
	3	458	495	532	569	606	644	681	718	755	792	829	867	904	941	978	1016	1052	1090	1127	1164	1201	1238	1275	1313	1350	1387	1514	1553	1594	1633	1671	1881	1925	1969
4	526	571	615	659	703	747	791	836	879	924	967	1011	1056	1100	1144	1188	1232	1277	1320	1365	1408	1452	1497	1541	1585	1629	1763	1809	1856	1903	1948	2164	2215	2266	
PG		100	110	120	130	140	150	160	170	180	190	200	210	220	230	240	250	260	270	280	290	300	310	320	330	340	350	360	370	380	390	400	410	420	430

DOPLĄTY DO KASETY

(cena z tabeli podstawowej + dopłata za kasetę)

KASETA

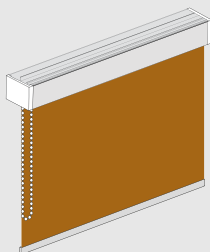

RSM 14 / RSM 64

		SZEROKOŚĆ																														
		130	140	150	160	170	180	190	200	210	220	230	240	250	260	270	280	290	300	310	320	330	340	350	360	370	380	390	400	410	420	430
KASETA		335	350	365	380	395	410	425	440	456	471	486	501	516	531	546	561	576	591	606	621	636	651	666	682	697	712	727	742	757	772	787

RSM-ROLETY
SMART L

OPCJE DODATKOWE

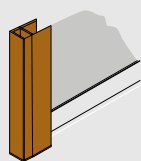

Profile boczne
Smart L

	PROFILE BOCZNE
130	174
140	187
150	200
160	213
170	225
180	239
190	251
200	264
210	277
220	290
230	303
240	316
250	329
260	342
270	354
280	368
290	380
300	393
310	406
320	419
330	432
340	445
350	458
360	471
370	483
380	497
390	509
400	522
410	535
420	548
430	561

WYSOKOŚĆ

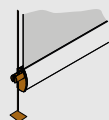

Prowadzenie boczne
(linka boczna + mocowanie
dolne standard
+ kątownik stalowy)

85,00 € /kpl.



Łańcuszek metalowy
ze spinką / bezkońcowy

3,10 € /mb.
łańcuszka obsługowego*



Łańcuszek bezkońcowy
PVC

7,40 € /szt.



Kątownik kaseta

7,50 €



Wspornik

28,50 €

ROLETY NASKRZYDŁOWE



Ważne

Szczegółowe informacje dotyczące wymiarów, kaset, komponentów oraz konstrukcji systemów roletowych, znajdziesz w folderze produktowym. Folder dostępny jest również w wersji elektronicznej na naszej stronie internetowej.



www.shadow-system.pl



Tabela podstawowa i dopłaty

Tabela podstawowa dla modelu:
RN BASIC (str. 47 - 48)

Tabela podstawowa dla modelu:
RN ULTIMATE (str. 49 - 50)

Dopłata do modeli:
RN BASIC i RN ULTIMATE (str. 51)

Tabela podstawowa dla modeli:
DECOMATIC® RN116, RN156 (str. 52 - 53)

Dopłata do modeli:
DECOMATIC® RN115, RN155 (str. 54)



Informacje

- 1 Do kalkulacji przyjmuje się wymiary zamówieniowe rolety. Dla rolet RN BASIC, RN ULTIMATE będą to wymiary tkaniny, dla rolet RN116 i RN156 będą to wymiary listwy przyszybowej, a dla rolet RN115 i RN155 będą to wymiary całkowite rolety.
- 2 Rolety naskrzydłowe należy zamontować do listw przyszybowych lub ramy skrzydła okiennego za pomocą dołączonych do wyrobu śrub montażowych. Blendy boczne montowane są za pomocą wytrzymałej taśmy dwustronnie klejącej.
- 3 Dla modeli RN BASIC, RN ULTIMATE, RN116 oraz RN156 w komplecie przewidziane są blendy boczne PCV.
- 4 Do okien z półokrągłymi listwami przyszybowymi można zastosować blendę łukową z PCV.



Kolory systemów ROLET NASKRZYDŁOWYCH

Basic:



BIAŁY



ANTRACYT



BRĄZOWY

Ultimate:



BIAŁY



SREBRNY

Basic & Ultimate:



DĄB ŻŁOTY

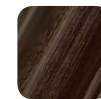

DĄB BAGIENNY

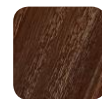

ORZECH



MAHOŃ

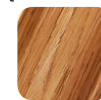

WINCHESTER

Decomatic® RN115, RN116, RN155, RN156:



BIAŁY
LAKIEROWANY



SREBRNY
ANODOWANY

RN-ROLETY ULTIMATE

coulisse
DECORATION SOLUTIONS

ROLETY NASKRZYDŁOWE

TABELA PODSTAWOWA

Podane ceny są cenami netto. Należy doliczyć VAT (23%)

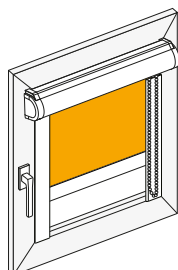

Maksymalna zalecana szerokość* : 150 cm.
Maksymalna zalecana wysokość* : 220 cm.
Wersje obstępowe: łańcuszek.
Kaseta: aluminiowa.
Blenda: PCV.
Mocowanie: skrzydło okienne.
Długość obstugi: 75% wysokości całkowitej rolety.

*w zależności od wybranego modelu tkaniny.
Szczegółowe informacje katalogu tkanin.

		SZEROKOŚĆ													
		PG	30	40	50	60	70	80	90	100	110	120	130	140	150
30	S		45	48	51	55	60	65	68	73	77	82	87	91	95
	0		47	51	55	60	65	69	75	78	83	88	93	97	102
	1		49	52	59	65	69	75	79	84	89	95	100	107	112
	2		50	55	61	67	73	79	84	91	96	102	109	115	119
40	3		51	59	65	70	77	83	89	96	103	109	116	123	129
	4		54	61	68	76	82	89	96	103	110	117	125	133	140
	S		46	50	54	58	63	67	70	76	80	84	89	95	98
	0		49	52	58	63	68	73	78	83	88	94	97	103	109
50	1		50	55	61	67	73	78	84	89	96	102	108	114	118
	2		52	59	66	71	78	84	91	97	103	110	116	123	131
	3		54	61	68	76	83	89	97	104	112	118	125	133	141
	4		56	66	73	80	88	96	104	113	121	129	136	145	153
60	S		47	51	55	60	65	69	75	78	83	88	94	98	103
	0		50	55	60	66	70	77	82	87	93	97	103	109	115
	1		52	59	65	70	77	83	89	95	102	108	115	121	126
	2		55	61	69	76	82	89	96	103	112	117	125	133	140
70	3		58	66	73	80	88	96	104	112	119	128	135	144	152
	4		60	69	78	87	95	104	113	121	132	140	150	159	166
	S		49	52	56	61	67	71	77	82	87	93	97	102	108
	0		51	56	63	68	75	79	86	91	97	103	109	115	119
80	1		54	61	68	75	80	87	95	100	108	115	121	129	135
	2		56	66	73	79	88	95	102	110	118	125	134	142	150
	3		60	68	77	86	94	102	112	119	129	136	145	154	163
	4		65	73	82	93	102	112	121	132	141	151	161	172	181
90	S		50	54	59	65	69	75	79	84	89	95	100	107	112
	0		52	59	66	70	77	83	89	96	102	108	115	119	126
	1		56	65	70	78	84	93	98	107	114	121	129	135	143
	2		60	68	76	84	93	100	109	117	125	134	142	151	160
100	3		63	73	80	91	99	109	118	128	136	146	156	165	175
	4		67	77	88	97	109	118	131	141	151	162	174	183	194
	S		51	55	61	67	70	77	82	87	94	98	104	110	116
	0		55	61	68	75	80	87	94	99	107	113	119	126	133
110	1		59	67	75	80	89	96	104	112	119	128	135	143	151
	2		63	70	79	88	97	107	115	124	133	142	151	160	168
	3		66	76	86	96	104	115	125	135	145	156	165	176	188
	4		69	80	93	103	115	126	137	150	161	174	183	196	208
120	S		52	58	63	68	75	79	84	91	96	102	108	114	119
	0		56	65	70	77	83	91	97	103	112	117	125	132	140
	1		60	68	77	84	94	100	109	117	125	134	142	151	160
	2		65	75	83	93	102	112	121	131	140	150	160	168	179
130	3		68	79	89	100	112	121	133	144	154	164	176	188	198
	4		73	84	97	110	121	134	146	160	173	183	196	209	222
	S		54	59	65	70	76	82	88	94	99	107	112	117	124
	0		59	66	73	79	87	94	100	109	116	123	131	137	145
140	1		63	70	79	88	97	107	115	123	132	141	150	159	166
	2		67	77	87	97	108	117	126	136	146	159	166	178	189
	3		70	82	94	104	117	129	140	151	163	175	185	198	209
	4		77	89	102	116	129	142	154	168	181	195	209	222	237
		PG	30	40	50	60	70	80	90	100	110	120	130	140	150

		SZEROKOŚĆ												
PG		30	40	50	60	70	80	90	100	110	120	130	140	150
110	S	55	61	67	73	78	84	91	96	102	109	116	121	129
	0	60	68	76	82	89	97	104	113	119	128	135	144	152
	1	66	75	83	93	100	110	118	129	137	146	156	165	176
	2	69	79	91	100	112	123	133	144	154	165	176	188	198
	3	75	87	98	110	123	134	146	160	173	183	196	209	222
120	4	79	94	108	121	135	150	163	178	192	207	221	234	249
	S	56	63	68	75	80	87	94	99	107	113	118	125	133
	0	63	69	78	84	94	100	109	117	125	133	141	150	159
	1	67	77	86	96	104	115	124	134	144	153	163	174	183
	2	71	83	95	104	116	128	140	151	162	174	184	196	208
130	3	77	89	102	115	129	141	154	166	180	194	207	219	233
	4	83	97	113	126	142	157	173	188	202	218	233	248	264
	S	59	65	70	77	83	89	96	102	109	116	123	131	136
	0	65	71	79	88	96	104	113	121	131	137	146	154	163
	1	69	79	89	98	109	118	131	140	151	161	172	181	192
140	2	75	87	97	110	121	133	145	157	168	181	194	205	218
	3	79	94	107	119	134	147	161	175	189	202	217	230	245
	4	86	102	117	133	150	164	180	196	212	229	245	261	278
	S	60	66	73	79	84	93	98	107	113	119	126	134	142
	0	66	75	82	91	99	109	117	125	134	143	152	161	170
150	1	71	82	93	103	113	124	134	145	156	166	179	189	200
	2	77	89	102	114	126	140	152	163	176	191	202	215	227
	3	82	96	112	125	140	154	168	182	198	212	227	241	258
	4	89	107	123	140	156	173	189	205	223	240	258	275	291
	S	61	68	75	80	88	95	102	109	116	124	132	137	146
160	0	68	77	84	94	103	112	121	131	140	147	159	166	176
	1	75	84	95	107	117	129	140	151	162	174	184	196	208
	2	79	93	104	118	132	144	159	172	183	198	210	224	238
	3	84	100	115	131	145	161	176	192	207	222	238	252	267
	4	93	110	126	145	162	180	198	215	233	250	269	287	306
170	S	63	69	77	83	91	97	104	113	119	126	135	142	151
	0	69	78	88	97	107	116	125	134	144	153	163	174	182
	1	76	87	98	110	121	133	145	157	168	180	193	204	217
	2	82	95	109	123	136	150	163	178	192	205	219	233	247
	3	88	103	119	135	151	166	182	199	215	231	247	264	280
180	4	96	114	133	151	168	188	207	224	243	262	281	301	320
	S	65	70	78	86	94	100	108	115	123	132	140	146	154
	0	70	80	91	99	110	118	129	140	150	160	168	179	189
	1	78	89	102	114	125	137	151	162	175	188	200	212	224
	2	84	98	113	126	141	156	170	183	199	214	228	243	258
190	3	91	108	124	141	157	174	191	207	223	241	258	276	291
	4	98	118	136	156	176	195	215	234	255	275	293	313	334
	S	66	73	80	88	95	103	110	118	126	134	143	151	160
	0	73	83	93	102	113	123	133	144	153	164	175	184	195
	1	80	93	104	117	131	142	156	168	181	194	207	221	233
200	2	87	102	116	132	146	161	176	192	207	222	238	252	267
	3	94	112	129	145	163	180	198	215	233	249	267	287	304
	4	102	123	142	162	182	202	223	243	264	286	306	326	347
	S	67	76	82	89	97	107	114	121	131	137	146	156	164
	0	75	84	95	107	116	126	136	147	159	170	180	192	202
210	1	82	95	109	121	134	147	161	174	188	201	214	228	241
	2	89	104	119	135	151	165	182	198	214	229	246	261	278
	3	97	115	133	151	168	185	205	223	241	260	278	297	315
	4	107	126	146	168	191	210	231	255	276	296	319	339	362
	S	69	77	84	93	100	109	116	125	134	142	151	160	168
220	0	77	87	97	109	119	131	141	152	163	175	185	196	208
	1	84	97	112	125	137	152	165	180	194	208	222	237	249
	2	93	108	124	140	156	173	189	205	221	238	255	271	288
	3	99	118	136	156	175	193	212	230	249	269	289	308	327
	4	109	131	152	175	196	218	240	262	286	307	329	353	375
230	S	70	78	87	95	103	112	119	129	136	146	154	164	174
	0	78	89	100	112	123	134	145	157	168	180	192	202	215
	1	87	100	115	129	142	157	172	185	200	214	229	245	259
	2	95	112	128	144	161	178	195	212	229	246	262	280	297
	3	102	121	141	161	180	200	219	239	259	279	299	320	339
240	4	113	135	159	180	202	226	248	272	296	319	343	366	390
	S	71	80	88	97	104	114	123	132	141	150	160	168	179
	0	80	93	103	115	126	137	150	162	174	184	196	209	222
	1	89	103	117	133	146	162	176	192	207	222	238	252	267
	2	97	114	132	147	165	183	201	218	237	255	271	289	307
250	3	104	125	145	165	185	207	227	247	267	289	309	329	352
	4	116	140	162	185	210	233	258	281	306	329	354	380	404
	PG	30	40	50	60	70	80	90	100	110	120	130	140	150

WYSOKOŚĆ

ROLETY
NASKRZYDŁOWE

BASIC & ULTIMATE DOPLĄTY

OPCJE DODATKOWE

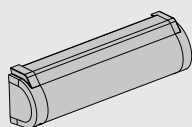

Dekor drewnopodobny -
kaseta + blendy boczne
(standardowe i łukowe)
orzech, mahoń,
dąb złoty, dąb bagienny
oraz winchester.

		SZEROKOŚĆ												
		30	40	50	60	70	80	90	100	110	120	130	140	150
WYSOKOŚĆ	30	8	10	10	11	12	13	16	17	18	19	20	21	23
	40	8	10	11	12	13	16	17	18	19	20	21	23	24
	50	10	11	12	13	16	17	18	19	20	21	23	24	27
	60	11	12	13	14	16	18	18	19	21	23	24	27	28
	70	12	13	14	16	17	18	19	21	23	24	27	28	30
	80	13	13	16	17	18	19	20	21	24	24	28	29	31
	90	14	16	17	18	19	20	21	24	27	28	29	30	32
	100	16	17	18	19	20	21	23	24	28	29	30	32	32
	110	17	18	19	20	21	23	24	27	28	30	31	33	35
	120	17	19	20	20	23	24	27	28	30	31	32	33	36
	130	19	19	20	21	24	27	28	29	31	32	33	35	37
	140	19	20	23	23	27	28	30	31	32	33	35	36	37
	150	20	21	23	24	27	29	31	31	33	35	36	37	38
	160	21	23	24	27	29	30	31	33	33	36	37	38	41
170	23	24	27	28	30	31	32	33	35	37	38	39	42	
180	24	27	28	29	31	32	33	35	36	38	39	41	45	
190	27	28	30	30	31	33	35	36	38	39	41	45	46	
200	27	29	30	31	33	35	36	37	39	39	42	46	47	
210	29	30	31	32	35	35	37	38	39	41	45	47	48	
220	30	31	32	33	35	37	38	39	41	45	46	48	49	
		SZEROKOŚĆ												
		30	40	50	60	70	80	90	100	110	120	130	140	150



Blenda łukowa
w kolorze białym, brązowym
i antracytowym oraz
w dekorach drewnopodobnych.

BEZ DOPŁATY

Alternatywa dla blendy standardowej PCV

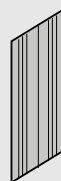

Blenda aluminiowa*
w kolorze białym
oraz srebrnym anodowanym.

10,00 € /mb.

*tylko dla RN ULTIMATE

TABELA PODSTAWOWA

Podane ceny są cenami netto. Należy doliczyć VAT (23%)

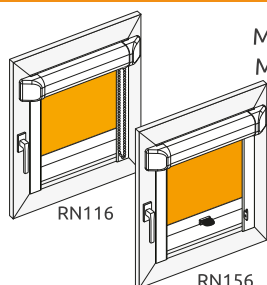

Maksymalna zalecana szerokość* : 150 cm.
 Maksymalna zalecana wysokość* : 220 cm.
 Wersje obsługowe* : łańcuszek.
 Kasety: aluminiowa.
 Blendy: PCV.
 Mocowanie: skrzydło okienne.
 Długość obsługi: 75% wysokości całkowitej rolety.

* w zależności od wybranego modelu rolety oraz tkaniny.
 Szczegółowe informacje w folderze produktowym i katalogu tkanin.

		SZEROKOŚĆ													
		PG	30	40	50	60	70	80	90	100	110	120	130	140	150
50	S		78	84	93	98	107	113	118	126	133	140	146	153	161
	0		97	107	115	123	132	141	150	157	165	175	183	192	200
	1		100	109	117	126	134	145	154	163	173	183	192	200	209
	2		103	115	123	134	145	154	165	178	185	198	209	217	228
	3		109	119	132	143	157	168	180	192	202	217	228	240	250
60	4		125	137	152	164	181	194	208	221	233	249	262	269	277
	S		80	87	95	100	110	117	124	131	137	144	151	159	164
	0		100	109	117	126	137	145	154	163	173	180	189	198	207
	1		103	112	123	132	141	152	161	168	180	189	200	209	217
	2		107	117	129	141	152	163	175	185	198	209	217	228	240
70	3		115	126	141	152	165	178	192	207	217	231	243	258	269
	4		132	145	161	175	192	204	221	238	249	266	279	282	296
	S		83	93	98	107	113	118	128	135	142	150	156	164	173
	0		103	115	123	132	141	150	161	168	178	185	195	207	214
	1		107	117	126	137	145	157	165	178	185	198	207	217	226
80	2		112	123	134	145	161	173	183	195	207	217	228	240	256
	3		119	132	145	161	175	189	202	217	231	246	260	275	286
	4		137	152	168	183	200	217	233	249	266	282	299	303	314
	S		87	95	100	108	117	124	131	140	146	153	161	170	176
	0		109	117	126	134	145	154	163	175	183	192	200	212	221
90	1		112	119	132	143	152	163	173	183	195	202	214	226	234
	2		117	129	141	154	165	178	192	202	214	228	240	256	266
	3		123	141	154	168	183	200	214	228	246	260	275	289	306
	4		142	161	178	194	210	230	246	262	282	299	315	318	336
	S		89	96	107	113	118	128	135	142	151	159	166	174	181
100	0		112	119	132	141	150	161	168	178	189	198	209	217	226
	1		115	126	134	145	157	168	180	189	200	212	223	231	243
	2		119	134	145	161	175	185	200	212	226	238	250	266	278
	3		129	145	163	178	195	209	226	243	258	275	289	306	323
	4		147	168	188	204	223	240	260	279	296	315	332	336	355
110	S		93	98	108	115	124	131	140	146	156	162	173	179	188
	0		115	123	134	143	154	163	175	183	195	202	214	223	234
	1		117	129	141	152	163	175	185	198	209	221	228	240	250
	2		126	141	154	165	180	195	209	223	234	248	262	278	291
	3		134	152	168	185	202	221	238	256	271	289	306	323	341
120	4		154	175	194	214	233	255	272	293	312	332	352	355	374
	S		95	103	110	118	128	135	144	151	161	166	176	184	193
	0		117	129	137	150	161	168	180	189	200	209	221	231	240
	1		123	134	145	157	168	180	192	202	214	226	238	248	260
	2		132	145	161	175	189	202	217	231	246	260	275	289	304
130	3		141	161	178	195	212	231	248	266	286	304	320	338	356
	4		161	183	204	223	243	266	286	306	328	347	368	371	392
	S		96	107	115	121	131	140	146	156	164	173	181	191	199
	0		119	132	143	152	163	175	183	195	207	214	226	238	248
	1		126	137	150	163	175	185	198	209	221	234	246	258	269
140	2		134	150	165	180	195	209	226	240	256	269	286	301	314
	3		145	165	183	202	223	240	260	280	297	318	334	354	374
	4		168	192	210	233	257	277	299	323	342	364	385	390	411
	PG		30	40	50	60	70	80	90	100	110	120	130	140	150



Ceny z tabeli obok dotyczą modeli w wersjach: łańcuszkowej RN116 uchwytowej - vario RN156
 Dopłaty do pozostałych wersji znajdziesz na stronie 54.

		SZEROKOŚĆ												
PG		30	40	50	60	70	80	90	100	110	120	130	140	150
130	S	100	108	117	126	135	142	151	161	170	179	184	195	204
	0	126	134	145	157	168	178	189	200	212	223	231	243	256
	1	129	143	154	165	180	192	202	217	228	240	256	266	278
	2	141	154	173	185	202	217	234	248	266	280	297	312	328
	3	152	173	192	212	231	250	271	291	312	331	352	372	391
4	175	198	221	243	266	289	312	335	357	381	404	409	431	
140	S	103	113	121	128	137	146	156	164	174	183	193	199	208
	0	129	141	152	161	173	183	195	207	217	228	240	248	260
	1	134	145	161	173	183	198	209	223	234	248	260	275	286
	2	143	161	178	192	209	226	243	258	275	291	306	323	341
	3	157	178	200	221	240	262	282	304	326	345	366	386	409
4	181	204	230	255	277	303	325	347	374	396	420	424	450	
150	S	107	115	124	133	142	151	161	170	179	188	196	207	215
	0	132	143	154	165	178	189	200	212	223	234	246	258	269
	1	137	152	163	178	189	202	217	228	243	256	269	282	294
	2	150	165	183	200	217	234	250	269	282	301	318	334	352
	3	163	185	207	228	250	271	294	318	338	361	384	403	425
4	188	214	238	262	289	312	339	364	387	413	440	443	469	
160	S	108	117	126	135	144	156	164	174	183	193	201	210	219
	0	134	145	157	168	180	195	207	217	228	240	250	262	275
	1	141	154	168	180	195	209	223	238	248	262	278	291	304
	2	152	173	189	207	223	240	260	278	294	312	328	345	366
	3	168	192	214	238	260	282	306	328	352	374	396	420	443
4	194	221	246	272	299	325	352	377	404	431	457	461	487	
170	S	110	121	131	140	150	159	166	179	188	196	207	215	224
	0	137	152	163	175	185	198	209	223	234	246	258	269	280
	1	145	157	173	185	200	214	228	243	258	271	286	297	312
	2	157	175	195	212	231	248	266	286	304	323	341	361	376
	3	175	198	223	246	269	294	318	341	366	389	411	437	459
4	200	227	257	282	308	339	364	391	420	448	472	481	506	
180	S	115	124	133	142	153	162	173	181	193	201	210	219	230
	0	143	154	165	178	192	202	214	226	240	250	262	275	289
	1	150	163	178	192	207	221	234	248	262	278	291	306	320
	2	163	180	200	221	238	258	275	294	314	331	352	372	389
	3	180	202	228	256	280	304	328	354	376	403	428	451	477
4	208	233	262	293	323	347	377	408	434	464	492	497	524	
190	S	117	126	135	146	156	166	176	184	196	207	215	227	237
	0	145	157	168	183	195	209	221	231	246	258	269	282	294
	1	152	165	183	198	212	226	240	256	271	286	301	314	328
	2	165	185	207	226	246	266	282	304	323	343	363	384	403
	3	185	212	238	262	289	314	341	366	391	418	443	469	494
4	214	243	272	303	332	362	391	420	450	480	509	516	543	
200	S	118	128	140	150	161	170	181	191	201	210	222	230	240
	0	150	161	175	185	200	212	226	238	250	262	278	289	301
	1	157	173	185	200	217	231	246	262	278	291	308	323	338
	2	173	192	212	231	250	271	291	312	334	354	374	394	413
	3	192	217	243	271	297	326	352	376	406	432	457	486	513
4	221	249	279	312	342	374	404	434	467	497	525	534	563	
210	S	121	133	142	153	162	174	183	195	207	215	227	237	247
	0	152	165	178	192	202	217	228	243	258	269	282	294	308
	1	161	175	192	207	223	238	256	269	286	301	314	331	345
	2	175	198	217	238	260	280	301	323	343	363	386	406	425
	3	198	223	250	280	306	334	363	391	418	446	473	500	529
4	227	257	289	323	352	385	418	450	480	513	545	550	581	
220	S	124	135	146	156	166	179	188	199	210	219	230	242	250
	0	154	168	183	195	209	223	234	248	262	275	289	304	314
	1	163	180	195	212	228	243	260	275	291	308	323	341	354
	2	180	202	223	246	266	289	308	331	352	374	396	418	439
	3	202	231	260	289	318	345	374	403	432	459	489	517	545
4	233	266	299	332	364	396	431	464	497	529	562	569	600	
PG		30	40	50	60	70	80	90	100	110	120	130	140	150

DOPLĄTY DO KASETY

(cena z tabeli podstawowej + dopłata)

KASETA
ALUMINIOWA PEŁNA

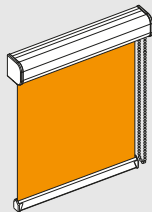

RN115

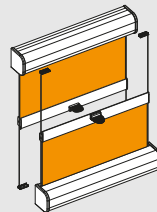

RN155

SZEROKOŚĆ

	30	40	50	60	70	80	90	100	110	120	130	140	150
KASETA PEŁNA	10	12	15	17	20	22	25	27	30	35	35	38	43

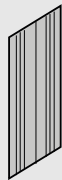

Blenda aluminiowa*
w kolorze białym oraz
srebrnym anodowanym.

* tylko dla RN116 i RN156.

NAZWA	BLENDY ALUMINIOWA
50	11
60	13
70	15
80	17
90	18
100	20
110	22
120	23
130	26
140	28
150	29
160	32
170	34
180	35
190	38
200	39
210	43
220	45

WYSOKOŚĆ

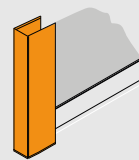

Profile boczne typu „U”**

** tylko dla RN115 i RN155.

NAZWA	PROFILI BOCZNE TYPU „U”
50	15
60	18
70	21
80	23
90	25
100	28
110	31
120	33
130	35
140	39
150	41
160	43
170	45
180	48
190	52
200	54
210	56
220	58

WYSOKOŚĆ

ROLETY DACHOWE



Ważne

Szczegółowe informacje dotyczące wymiarów, kaset, komponentów oraz konstrukcji systemów roletowych, znajdziesz w folderze produktowym. Folder dostępny jest również w wersji elektronicznej na naszej stronie internetowej.



www.shadow-system.pl



Kolory systemu SKYLIGHT

E6/EV1

SREBRNY
ANODOWANY



Tabela podstawowa

Tabela podstawowa dla modelu:
RD10 - roleta napięta samocharowna (str. 56).

Tabela podstawowa dla modelu:
RD20 - roleta napięta z profilem dolnym blokującym (str. 57).



Informacje

- 1 Tabela cenowa dla rolet dachowych składa się z modułów rozmiarowych. Każdy moduł odzwierciedla określony rozmiar (szerokość - wysokość) okna dachowego. Rozmiary modułów pokrywają się z wymiarami większości okien dachowych oferowanych przez największych europejskich producentów.
- 2 Składając zamówienie na roletę dachową, należy podać wymiary – szerokość i wysokość wewnętrznej ramy okna. Aby wykluczyć wszelkie pomyłki należy również podać w uwagach symbol, typ okna dachowego oraz rok produkcji. Informacje te można znaleźć na tabliczce znamionowej znajdującej się na ramie okna.

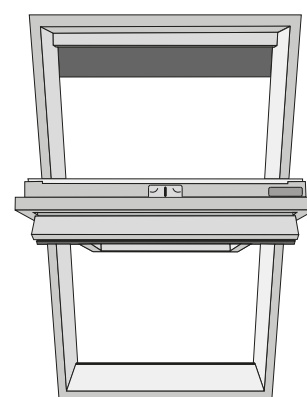

Tabliczka
znamionowa

ROLETY DACHOWE

ROLETY DACHOWE SKYLIGHT

TABELA PODSTAWOWA

Podane ceny są cenami netto. Należy doliczyć VAT (23%)

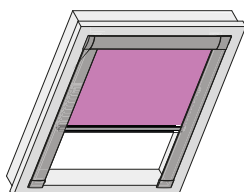

RD10 roleta napięta samochemowna,
z blendą górną i blendami bocznymi

Maks. szerokość: 118 cm.

Maks. wysokość: 136 cm.

Wersje obsługowe: obsługa profilem dolnym.

		SZEROKOŚĆ						
PG		38	50	62	78	98	118	
WYSOKOŚĆ	55	S	110	129	142	152	179	181
		0	123	145	164	178	218	219
		1	129	157	180	195	245	246
		2	137	168	198	215	275	277
		3	144	180	213	233	301	304
	4	153	193	231	255	332	334	
	74	S	123	129	142	152	179	181
		0	135	145	164	178	218	219
		1	144	157	180	195	245	246
		2	154	168	198	215	275	277
		3	163	180	213	233	301	304
	4	174	193	231	255	332	334	
	94	S	137	137	152	162	179	208
		0	157	157	180	194	218	261
		1	172	172	198	215	245	299
		2	185	185	219	239	275	341
		3	199	199	238	260	301	376
	4	214	214	260	286	332	422	
	116	S	162	162	162	174	191	208
		0	194	194	194	209	237	261
1		215	215	215	234	266	299	
2		240	240	240	262	303	341	
3		261	261	261	287	332	376	
4	287	287	287	315	370	422		
136	S	173	173	173	183	200	218	
	0	208	208	208	224	251	277	
	1	231	231	231	252	285	318	
	2	260	260	260	284	324	362	
	3	286	286	286	313	357	403	
4	314	314	314	346	401	452		
PG		38	50	62	78	98	118	
		SZEROKOŚĆ						

WAŻNE



Prosty montaż, wykonany precyzyjnie i zgodnie z instrukcją, nie narusza żadnych elementów okna, których uszkodzenie mogłoby prowadzić do utraty gwarancji na okno.

ROLETY DACHOWE SKYLIGHT

TABELA PODSTAWOWA

Podane ceny są cenami netto. Należy doliczyć VAT (23%)

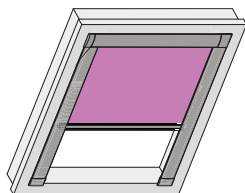

RD20 roleta napięta z profilem dolnym blokującym, z blendą górną i blendami bocznymi

Maks. szerokość: 118 cm.

Maks. wysokość: 136 cm.

Wersje obsługowe: obsługa profilem dolnym.

		SZEROKOŚĆ					
PG		38	50	62	78	98	118
55	S	102	118	132	141	165	168
	0	113	134	153	165	204	207
	1	118	145	168	183	230	233
	2	126	159	185	202	260	262
	3	134	168	201	221	287	289
	4	143	182	219	242	319	322
74	S	113	118	132	141	165	168
	0	125	134	153	165	204	207
	1	134	145	168	183	230	233
	2	143	159	185	202	260	262
	3	152	168	201	221	287	289
	4	163	182	219	242	319	322
94	S	128	128	141	151	165	194
	0	145	145	166	181	204	246
	1	160	160	184	201	230	282
	2	174	174	207	226	260	325
	3	188	188	224	247	287	362
	4	202	202	247	272	319	406
116	S	151	151	151	161	178	194
	0	180	180	180	195	221	246
	1	202	202	202	221	252	282
	2	227	227	227	248	287	325
	3	248	248	248	272	318	362
	4	275	275	275	303	354	406
136	S	160	160	160	170	188	202
	0	194	194	194	209	236	260
	1	218	218	218	239	270	300
	2	246	246	246	270	309	347
	3	271	271	271	298	343	386
	4	301	301	301	332	384	436
PG		38	50	62	78	98	118
		SZEROKOŚĆ					



NAPĘDY ELEKTRYCZNE I STEROWANIE



NAPĘDY



NAPĘDY BATERYJNE STEROWANIE RTS & Zigbee



Silnik Sonesse 28 WF RTS
zasilanie Li-Ion 12 V 2600 mAh

(1003296 - 1,1/28)
260,00 €

Minimalne szerokości rolety: 0,64m



Silnik Sonesse ULTRA 30 WF RTS
zasilanie Li-Ion 12 V 2600 mAh

(1003311)
279,00 €

Minimalne szerokości rolety: 0,75m



zigbee
Silnik Sonesse 2 28 Zigbee
zasilanie Li-Ion 12 V 2600 mAh

(1245944)
280,00 €



zigbee
Silnik Sonesse 2 ULTRA 30 Zigbee
zasilanie Li-Ion 12 V 2600 mAh

(1245933)
330,00 €



Silnik Sonesse 40 WF RTS Li-Ion
3Nm | 28U / Min. | 12 V | 4600 mAh

(1240486)
441,00 €

Minimalne szerokości rolety: 0,75m



Silnik Sonesse 40 Zigbee
3Nm | 28U / Min. | 12 V | 4600 mAh

(1245994)
580,00 €



NAPĘD 24V



Silnik Roll Up 28 WT
zasilanie 24 V

(1002833)

Minimalne szerokości rolety: 0,64m

220,00 €



zigbee
Silnik Roll Up 24 Zigbee
zasilanie 24 V

(1246036)

205,00 €



NAPĘD 230V STEROWANIE RTS / IO / ZIGBEE



Silnik Sonesse 40 RTS
zasilanie 230 V

(1001574 - 3/30) **319,00 €**
(1001578 - 6/20) **344,00 €**
(1001582 - 9/12) **344,00 €**

Minimalne szerokości rolety: 0,64m



Silnik Sonesse 40 io
zasilanie 230 V

(1003222 - 1,3/50) **369,00 €**
(1003224 - 3/30) **338,00 €**
(1003226 - 6/20) **350,00 €**
(1240605 - 9/2) **356,00 €**

Minimalne szerokości rolety: 0,64m



zigbee
Silnik Sonesse 40 R1 Zigbee
zasilanie 230 V

(1245917 - 3/30) **350,00 €**
(1245918 - 6/20) **372,00 €**
(1245919 - 9/12) **368,00 €**

NAPĘDY ELEKTRYCZNE I STEROWANIE



 **NAPĘD 230V**
STEROWANIE PRZEWODOWE



Silnik Sonesse 40 PA
zasilanie 230 V

(1001548 - 3/30) **222,00 €**
(1001549 - 6/20) **227,00 €**
(1001552 - 9/12) **234,00 €**

Minimalne szerokości rolety: 0,57m



ZASILANIE 12 V



Zasilacz z wtyczką
do ładowania akumulatorów
LI-ION w napędach:
Sonesse 28 WF RTS
Sonesse ULTRA 30 WF RTS

(9021028)
31,00 €



ZASILANIE 24 V



Zasilacz z wtyczką
230 / 24 V DC, 1 A

(1870279)
68,00 €



Zasilacz podtynkowy
24 V DC, 1.0 A

(1870274)
171,00 €



Zasilacz POWER 1,5
zasilacz grupowy, 24 V,
w zestawie z przewodem

(1870149)
98,00 €



Zasilacz POWER 2,5
zasilacz grupowy, 24 V

(1870157)
399,00 €



Zasilacz POWER 2,7
zasilacz grupowy, 24 V

(1870156)
258,00 €



Zasilacz ANIMEO DC
zasilacz grupowy, 24 V, 4,5 A

(1860093)
350,00 €



STEROWANIE PRZEWODOWE 24 V



Inis DC 24 V
przetątnik z zasilaczem

(1870071)
178,00 €

W zestawie bez ramki



NAPĘDY ELEKTRYCZNE I STEROWANIE



STEROWANIE PRZEWODOWE 230 V



Smoove Uno WT
przełącznik z podtrzymaniem
230 V

(1800508)
31,00 €



Smoove Duo WT
przełącznik z podtrzymaniem
230 V

(1800506)
44,00 €



Smoove Uno IB+
przełącznik 230 V
(1811203 - pure)
(1811204 - silver)
(1811205 - black)

117,00 €

W zestawie bez ramki



Smoove Origin IB+
przełącznik 230 V

(1811272)
62,00 €

W zestawie bez ramki



Chronis Smoove Uno
przełącznik czasowy 230 V

(1805270)
196,00 €

W zestawie z ramką



TR2-U-E-230
przełącznik separujący

(1822200)
77,00 €



STEROWANIE BEZPRZEWODOWE W TECHNOLOGII RTS



W zestawie z ramką

Smoove Origin RTS
przełącznik bezprzewodowy
(1-kanalowy 1811045)

59,00 €

(2-kanalowy 1800223)

94,00 €

(4-kanalowy 1800295)

115,00 €



Situo 1 RTS II
pilot jednocanalowy
pure *

(1870403)

€ 77,00



Situo 5 RTS II
pilot pięciokanalowy
pure *

(1870419)

€ 98,00



Telis Chronis Pure 6 RTS
pilot sześciokanalowy z
programatorem czasowym
biały *

(1805215)

258,00 €



Telis 16 Pure RTS
pilot szesnastokanalowy
biały *

(1811079)

222,00 €

* inne kolory dostępne na zamówienie wg aktualnego cennika SOMFY

NAPĘDY ELEKTRYCZNE I STEROWANIE



STEROWANIE io-homecontrol



Situio 1 io II
pilot jednocanałowy

(1870312)
62,00 €



Situio 5 io II
pilot pięciocanałowy

(1870328)
105,00 €



W zestawie z ramką

Smoove Origin io
przełącznik zasilany bateriami
(1-canałowy 1811003)

80,00 €
(2-canałowy 1800204)
94,00 €
(4-canałowy 1800205)
115,00 €



STEROWANIE BEZPRZEWODOWE W TECHNOLOGII ZIGBEE



Ysia 1 Zigbee
pilot jednocanałowy
biały

(1871397)
65,00 €



Ysia 5 Zigbee
pilot pięciocanałowy
biały

(1871399)
85,00 €



ODBIORNIKI RTS 24 V



Modulis DC
odbiornik radiowy
zewnętrzny RTS, 24 V

(1870138)
161,00 €



CENTRALA



TaHoma@ Switch
Centrala inteligentnego domu

(1870594)
286,00 €



RAMKI DO PRZEŁĄCZNIKÓW*



Ramka PURE
(9015022)
6,20 €



Ramka BLACK
(9015023)
14,80 €



Ramka SILVER
(9015024)
14,80 €



Ramka PURE Podwójna
(9015238)
9,80 €



NAPĘDY ELEKTRYCZNE BREL



NAPĘDY



NAPĘDY BATERYJNE

STEROWANIE RADIOWE / BI-DIRECTIONAL



Silnik Lio BLE25
1,1 Nm / 28 obr. / 12 V

160,00 €

systemy: RC, RM

Minimalne szerokości rolety: 0,58m



Silnik Lio BLEQ28
2 Nm / 28 obr. / 12 V

260,00 €

systemy: RM, RMP, RL

Minimalne szerokości rolety: 0,74m



Silnik Lio BLEQ35
6 Nm / 24 obr. / 12 V

300,00 €

systemy: RM, RMP, RL

Minimalne szerokości rolety: 0,79m



Silnik Lio BLE35
13 Nm / 10 obr. / 12 V

290,00 €

systemy: RM, RMP, RL

Minimalne szerokości rolety: 0,77m



 **matter**
Silnik Matter BLEMQ35
6 Nm / 24 obr. / 5 V

315,00 €

systemy: RM, RMP, RL

Minimalne szerokości rolety: 0,79m



 **matter**
Silnik Matter BLEM35
13 Nm / 11 obr. / 5 V

305,00 €

systemy: RM, RMP, RL

Minimalne szerokości rolety: 0,77m



NAPĘD 230 V

STEROWANIE RADIOWE / BI-DIRECTIONAL



Silnik Nino BPE25
1,5 Nm / 32 obr. / 230 V

160,00 €

systemy: RC, RM

Minimalne szerokości rolety: 0,74m



Silnik Vesta BPEQ28
2 Nm / 28 obr. / 230 V

252,00 €

systemy: RM, RMP, RL

Minimalne szerokości rolety: 0,74m



Silnik Nino BEQ35
6 Nm / 28 obr. / 230 V

190,00 €

systemy: RM, RMP, RL

10 Nm / 17 obr. / 230 V

190,00 €

Minimalne szerokości rolety: 0,79m



 **matter**
Silnik Matter BEMQ35
6 Nm / 28 obr. / 230 V

205,00 €

systemy: RM, RMP, RL

10 Nm / 17 obr. / 230 V

205,00 €

NAPĘDY ELEKTRYCZNE BREL



NAPĘD 230 V STEROWANIE PRZEWODOWE



systemy: RM, RMP, RL

Silnik Ezio MBQ35

6 Nm / 28 obr. / 230 V

150,00 €

10 Nm / 17 obr. / 230 V

150,00 €

Minimalne szerokości rolety: 0,65m



systemy: RC, RM

Silnik Ezio MS25

1,5 Nm / 32 obr. / 230 V

165,00 €

Minimalne szerokości rolety: 0,54m



systemy: RM, RMP, RL

Silnik Ezio MS 35-10

10 Nm / 17 obr. / 230 V

140,00 €



STEROWANIE



Pilot One pilot 1-kanatowy

(DD-2700)

50,00 €



Pilot Multi pilot 15-kanatowy

(DD-2702)

60,00 €



Przełącznik ścienny One przełącznik 1-kanatowy

(DD-2770)

47,00 €



Przełącznik ścienny Multi Display przełącznik 15-kanatowy

(DD-2773)

55,00 €



BREL HOME Hub Bi-directional centrala do sterowania za pomocą aplikacji mobilnej

(DD-1554)

196,00 €



STEROWANIE DO NAPĘDÓW 230V (MS25 i MBQ35)



Odbiornik Bi-directional

Pozwala na radiowe sterowanie
napędami za pomocą pilota

(DD-50)

64,00 €



Przełącznik ścienny z wbudowanym odbiornikiem

Przewodowe sterowanie napędami
+ możliwość sterowania pilotem.

(DD-1690)

79,00 €



Moduł grupy do napędów przewodowych 230 V

Równoległe sterowanie grupą rolet

(DC-209)

55,00 €



NAPĘDY ELEKTRYCZNE BREL



AKCESORIA



Kabel
z wtyczką USB-A i USB-C
3 m

(Z-48-300)
19,00 €



Ładowarka USB

(DC-220)
21,00 €



Panel solarny
ze złączem Micro USB | bez obudowy
400 x 50 x 8 mm

(DC-1288)
115,00 €



Panel solarny
ze złączem Micro USB | z obudową
475 x 50 x 10 mm

(DC-1288G)
84,00 €



Kabel USB-A z magnetycznym
złączem
do ładowania akumulatorów
3 m

(Z-42-300M)
13,00 €



Adapter
wtyczka Micro-USB i USB-C do podłączenia
panelu słonecznego z silnikiem baterii.

(Z-48-004)
14,00 €

APLIKACJA DO STEROWANIA
NAPĘDAMI RADIOWYMI /
BI-DIRECTIONAL

DO STEROWANIA NAPĘDAMI ZA POMOCĄ APLIKACJI
POTRZEBUJESZ **BREL-HOME HUB** (str. 52)

NAPĘDY ELEKTRYCZNE I STEROWANIE

coulisse
DECORATION SOLUTIONS



NAPĘDY DO ROLET SMART



NAPĘD BATERYJNY



Silnik Coulisse CM-02
0,65 Nm | 34 Obr. | 7,4 V | 750

154,00 €



Silnik Coulisse CM-03
1,1 Nm | 28 Obr. | 12 V | 2600 mAh

196,00 €



NAPĘD BATERYJNY

STEROWANIE BLUETOOTH / WI-FI / RADIO



CM-06
6,0 Nm | 24 Obr. | 12V | 3200 mAh

341,00 €



CM-06-EVE
6,0 Nm | 24 Obr. | 12 V | 3200 mAh.

383,00 €



NAPĘD 230V

STEROWANIE BLUETOOTH / WI-FI / RADIO



CM-10-QC
8,0 Nm | 15 Obr. | 230 V

304,00 €



NAPĘD 230 V

STEROWANIE PRZEWODOWE



CM-9-MC
6,0 Nm | 28 Obr. | 230 V

155,00 €



STEROWANIE DO ROLET SMART



Pilot CM-11
pilot jednokanałowy

27,00 €



Pilot CM-12
pilot pięciokanałowy

38,00 €



Pilot CM-13
pilot piętnastokanałowy

57,00 €

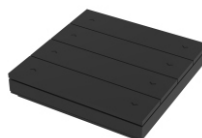

Przełącznik CM-16
przełącznik czterokanałowy

129,00 €



Przełącznik CM-18
przełącznik jednokanałowy

47,00 €



CM-19
automatyka domowa

203,00 €



CMD-01
Mostek Wi-Fi motion

142,00 €



CM-20
most wi-fi

142,00 €

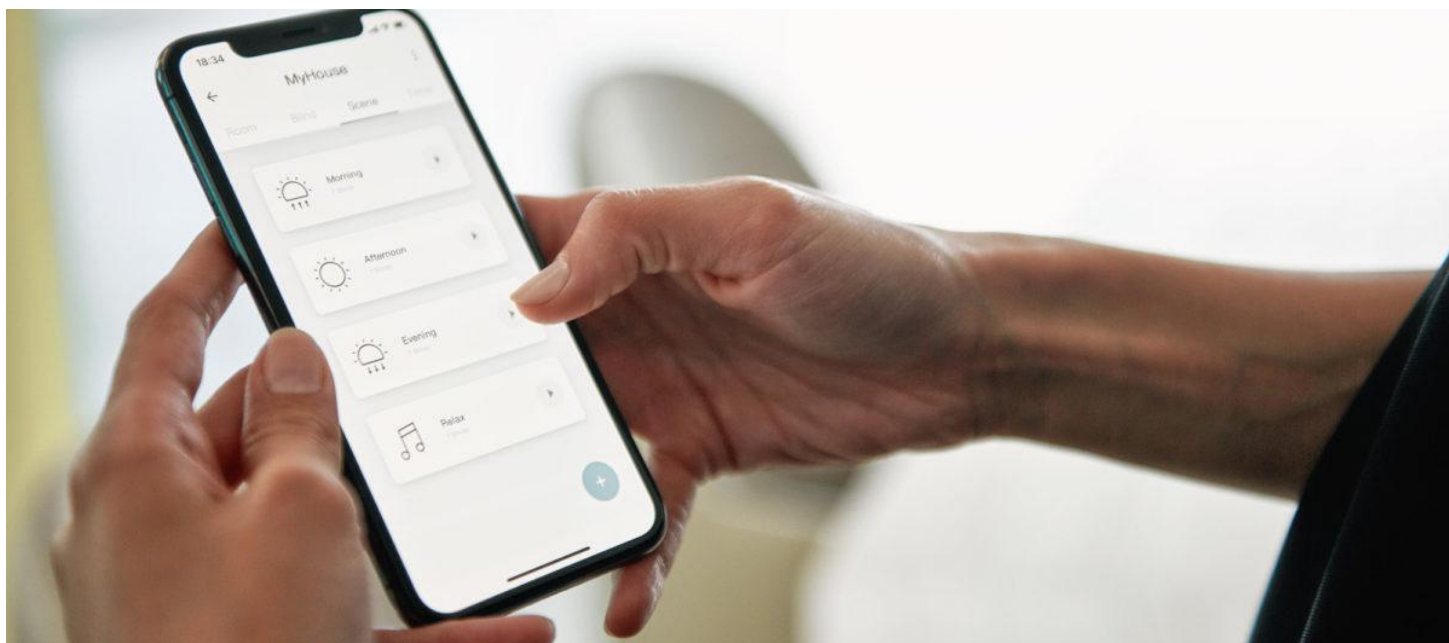

APLIKACJA MOBILNA COULISSE - MOTION BLINDS WYŻSZY POZIOM OBSŁUGI

Jednoczesne sterowanie wieloma roletami za pomocą prostej w obsłudze aplikacji Motion Blinds. Zautomatyzuj dom dzięki zaprogramowanym trybom działania i programatorowi czasowemu. Kontroluj klimat wnętrza ograniczając utratę energii termicznej. Znajdź właściwą równowagę między ilością światła i ochroną prywatności. Dzięki aplikacji Motion Blinds ustawisz optymalną pozycję rolet oraz sprawdzisz aktualny stan baterii.

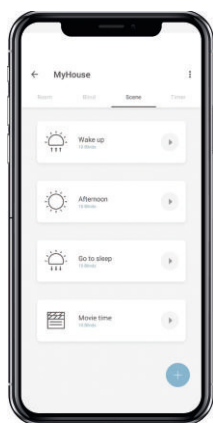

Ustaw scenariusze w zależności od sytuacji

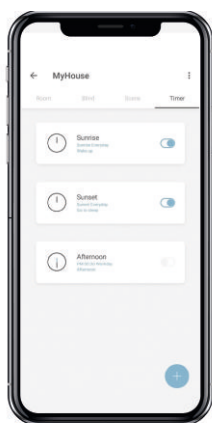

Zaprogramuj czas automatycznej pracy rolet

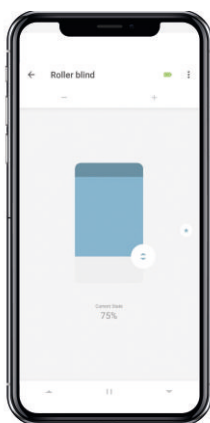

Kontroluj ustawienie rolet i stan baterii

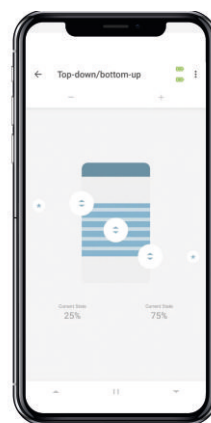

Ustaw rolety w dowolnie wybranej pozycji

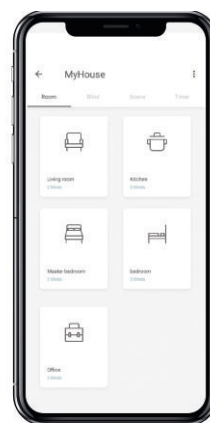

Konfiguruj pomieszczenia z różnymi grupami rolet

Pobierz aplikację Motion Blinds na urządzenie mobilne ze sklepu App Store lub Google Play!



OGÓLNE WARUNKI GWARANCJI

- 1** Firma SHADOW-SYSTEM Sp. z o.o. z siedzibą w Kawle Dolne 4F, 83-304 Przdokowo, zwana dalej Gwarantem, gwarantuje dobrą jakość oraz sprawne działanie nowego produktu, zgodnie ze standardami przewidzianymi dla danego rodzaju produktów, z zastrzeżeniem użytkowania zgodnego z przeznaczeniem, w normalnych warunkach.
- 2** SHADOW-SYSTEM Sp. z o.o. udziela gwarancji:
 - 36 miesięcy od daty zakupu na systemy żaluzjowe oraz roletowe,
 - 12 miesięcy od daty zakupu na tkaniny, lamele drewniane i aluminiowe.
- 3** Gwarancja obejmuje wady fabryczne powstałe z winy Producenta. Za takie uznaje się zastosowanie wadliwych materiałów, błędy produkcyjne i błędy konstrukcyjne.
- 4** Podczas fizycznego odbioru produktu w siedzibie Gwaranta lub w dniu dostarczenia produktu za pośrednictwem firmy spedycyjnej Kupujący zobowiązany jest sprawdzić jakość, wymiary oraz kompletność dostarczonego produktu zgodnie z zamówieniem, pod rygorem utraty prawa kwestionowania jakości i kompletności dostawy.
- 5** W przypadku stwierdzenia wady produktu, Kupujący zobowiązany jest poinformować o tym Gwaranta w ciągu 14 dni. Niespełnienie powyższych warunków, skutkować będzie utratą uprawnień z tytułu gwarancji.
- 6** Wszystkie reklamacje z tytułu gwarancji rozpatrywane są wyłącznie w siedzibie Gwaranta (SHADOW-SYSTEM Sp. z o.o., Kawle Dolne 4F, 83-304 Przdokowo). Strony indywidualnie ustalą sposób przekazania reklamowanego produktu do w/w siedziby.
- 7** Podstawą złożenia reklamacji z tytułu gwarancji jest oryginalny dokument zakupu (paragon lub faktura) oraz kompletnie wypełniony dokument reklamacyjny.
- 8** Wypełniony druk reklamacyjny, zeskanowany dowód zakupu oraz dokumentację fotograficzną, należy wysłać na adres e-mail: info@shadow-system.pl
- 9** Gwarant zobowiązuje się do rozpatrzenia zasadności reklamacji z tytułu gwarancji w terminie 14 dni od daty otrzymania pisemnej reklamacji, a w przypadku gdy niezbędne jest dokonanie oględzin towaru posiadającego wadę, w ciągu 14 dni od daty zwrotnego przestania towaru do siedziby Gwaranta.
- 10** Gwarant nie ponosi odpowiedzialności w przypadku:
 - uszkodzeń mechanicznych oraz uszkodzeń będących wynikiem niewłaściwego lub niedbałego użytkowania, przechowywania, oraz eksploatacji w niewłaściwych warunkach,
 - naturalnego zużycia oryginalnych elementów, części i akcesoriów spowodowanych ich normalną eksploatacją,
 - modyfikacji oryginalnego produktu oraz ingerencji w jego konstrukcję przez osoby trzecie, a także użycia części zamiennych lub akcesoriów innych niż stosowane przez Gwaranta,
 - jakichkolwiek napraw dokonywanych przez osoby trzecie,
 - montażu niezgodnym z zasadami sztuki budowlanej oraz z zaleceniami producenta,
 - użytkowania niezgodnie z instrukcją obsługi,
 - wydzielania przez produkt zapachów pochodzących z komponentów użytych do produkcji (np. naturalny zapach lameli bambusowych),
 - naturalnych niewielkich odkształceń płaszczyzny taśmy aluminiowej, lameli drewnianych i powierzchni tkanin,
 - różnic w odcieniach i fakturze lameli drewnianych wynikających z naturalnych właściwości drewna,
 - odbarwień oraz innych zmian właściwości powierzchni elementów, spowodowanych działaniem warunków atmosferycznych,
 - różnic w kolorystyce między rzeczywistym wyrobem, a nieaktualnym próbnikiem lub katalogiem,
 - konserwacji, czyszczenia produktów, wymiany baterii w podzespołach elektrycznych,
 - uszkodzeń powstałych wskutek zdarzeń losowych (pożar, powódź, uderzenie pioruna, niskie lub zbyt wysokie temperatury oraz inne klęski żywiołowe).
- 11** Produkty przekraczające minimalne oraz maksymalne zalecane wymiary określone w informacji technicznej, nie podlegają ogólnym warunkom gwarancji i wykonywane są na wyłączną odpowiedzialność Kupującego. W takim przypadku Gwarant dąży wszelkimi staraniami aby produkt był w pełni sprawny.
- 12** W przypadku uznania reklamacji, Gwarant zobowiązuje się do naprawy lub wymiany wadliwego towaru w możliwie najkrótszym terminie.
- 13** Gdy naprawa lub wymiana będzie niemożliwa albo będzie wymagać nadmiernych kosztów, Gwarant zobowiązuje się do przyjęcia wadliwego towaru oraz zwrotu kosztów zakupu.
- 14** W przypadku uznania reklamacji i braku możliwości usunięcia wad fabrycznych taśmy aluminiowej, lameli drewnianej lub tkaniny z powodu np. wycofania z oferty w okresie trwania gwarancji, Gwarant może zaproponować wymianę na inny, zbliżony kolorystycznie komponent.
- 15** W przypadku, gdy reklamacja zostanie uznana za bezzasadną nastąpi zwrot towaru na koszt Kupującego.
- 16** Gwarancja w odniesieniu do towarów konsumpcyjnych w rozumieniu ustawy z dnia 27.07.2002 r. o szczególnych warunkach sprzedaży konsumenckiej oraz zmianie kodeksu cywilnego (Dz.U. 2002/141/1176), nie wyłącza, nie ogranicza ani nie zawiesza uprawnień Kupującego wynikających z niezgodności towaru z umową.



Shadow-System Sp. z o. o.

**Kawle Dolne 4F
83-304 Przekowo**

tel. +48 58 550 08 80

fax. +48 58 550 76 52

info@shadow-system.pl

www.shadow-system.pl



**Rolety
Cennik Detaliczny**