



Pleated Blinds Retail Price List

01.03.2025

shadow
SYSTEM



SHADOW-SYSTEM RETAIL PRICE LIST INCLUDING VAT

Remember you can have an influence on the design and content of our product brochures and price lists.

We appreciate cooperation with our customers and we rely on open communication.

If you have any comments or ideas how to improve the materials prepared, we would be happy to get to know your opinion.

TABLE OF CONTENTS

DECOMATIC® BASIC	05
Basic price table	06
Extra charges	09
DECOMATIC® COMFORT	10
Basic price table	11
Extra charges	14
DECOMATIC® PLAFOND	21
Basic price table	22
Extra charges	26
SMART PLEATED BLINDS	29
Basic price table	30
Extra charges	33
DECOMATIC® 16mm -	34
Basic price table	35
COULISSE SKYLIGHT -	37
Basic price table	38
Extra charges - components for pleated blinds DECOMATIC	39
Extra charges - components for pleated blinds SMART	44
Extra charges - electric motors and controls for free hanging roller blinds	45
General Terms and Warranty Conditions	51

HOW TO USE THE PRICE LIST? **IT'S SIMPLE!** FOLLOW THE INSTRUCTIONS BELOW!



01. Dimensions

Take the measurements for the selected pleated blind.



02. Price

Find the price for given dimensions in the price table, according to the price group **(PG)** of chosen fabric .







03. Extra charges

You will find extra charges for certain models, electric motors and controls and optional accessories in the extra charge section.



04. Important

Note the icons.    
You will find their meaning at the bottom of pages in the further part of the price list. If you have any questions, please contact our Customer Service.

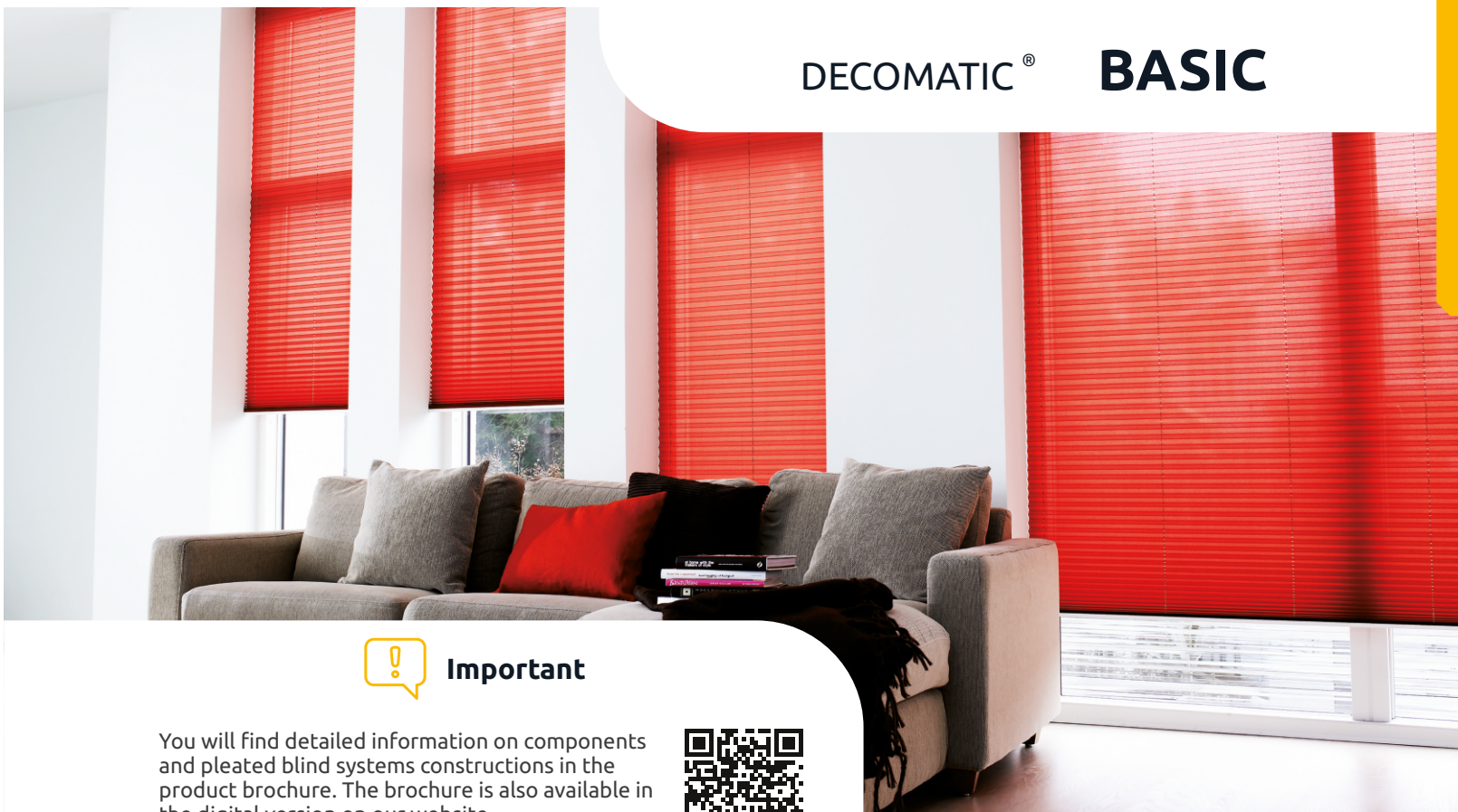

 **Important**

You will find detailed information on components and pleated blind systems constructions in the product brochure. The brochure is also available in the digital version on our website.



 **Informations**

- 1 Standard elements used for fixing are mounting feet or clips. With a ready-made pleated blind you will receive a set of standard mounting parts necessary for mounting a certain pleated blind model.
- 2 The standard colors of the profile in the BASIC range are lacquered white, structured white and silver anodized. Other colors: lacquered beige, structured grey, structured anthracite and structured black are available at an extra charge in accordance with the surcharge table on page 9
- 3 For pleated blinds wider than 1,00m a PLUS profile 20 x 23mm (width x height) is used instead of the standard profile (17 mm height). It is possible to order pleated blinds with a width of less than 1.00 m with a reinforced profile for a surcharge according to the surcharge table on page 9 - simply tick the appropriate box on the order form.
- 4 Pleated blinds model: **P1415N BIS**, consist of two fabrics. To calculate the price of such a pleated blind summarise the basic pleated blind price with the first fabric and the basic pleated blind price with the second fabric, considering the fabric price group each time. This icon  will remind you to take into account the second fabric in the pricing.
- 5 Maximum possible fabric widths are given in the fabric collection books. If a pleated blind exceeds this value, the fabric may require a vertical connection.
- 6 Profiles can be powder coated in any RAL colour (individual pricing). Other components (end caps, mounting parts) are available in standard colours.
- 7 At customer's request we can modify a previously produced pleated blind. Such a pricing is prepared by our Customer Service. Modification in a pleated blind is made according to the applicable technology (e.g. decrease of blind, replacement of fabric or cords).



Colours of the BASIC profiles

RAL 9016

WHITE POWDER COATED

RAL 9016

WHITE STRUCTUR

E6/EV1

SILVER ANODISED

EXTRA CHARGE:

RAL 9010

OFF WHITE STRUCTUR



BRONZE ANODISED

RAL 9001

CREME STRUCTUR

RAL 1015

BEIGE POWDER COATED

RAL 7040

GREY STRUCTUR

RAL 7016

ANTHRACITE* STRUCTUR

DB 703

DARK GREY POWDER COATED

RAL 9005

BLACK STRUCTUR

* Components (mounting feet, handles, side caps) in black

RECOMMENDED RETAIL PRICES INCLUDING VAT / 05

BASIC PROGRAM

BASIC TABLE

Recommended retail prices including VAT

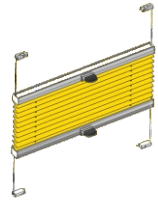

! Maximum production dimensions for each model are specified in the product brochure.
 Check it out!

Mounting parts*: mounting feet, clips, block holders, adjustable brackets.
 Types of operation*: handle

*depending on a pleated blind model.
 Detailed information in the product brochure and fabric catalogue.

		WIDTH												
PG		40	50	60	70	80	90	100	110	120	130	140	150	160
70	S	70	73	77	89	95	107	113	119	131	137	144	153	160
	0	77	80	87	98	105	118	125	133	145	153	160	170	178
	1	80	86	95	105	119	135	144	154	164	174	183	193	203
	2	89	95	104	119	134	147	163	173	188	198	212	222	237
	3	98	104	118	133	143	168	178	192	207	221	236	249	266
4	113	120	136	153	164	193	204	220	238	255	270	287	306	
80	S	71	75	79	90	97	109	116	123	135	142	147	157	164
	0	79	83	89	100	109	122	129	136	150	157	165	175	183
	1	83	89	98	109	124	138	150	160	170	180	189	200	210
	2	93	98	109	124	138	154	170	180	195	205	221	230	247
	3	102	109	124	138	150	175	185	200	215	230	247	262	277
4	117	125	143	159	172	201	214	229	247	265	284	302	318	
90	S	74	78	83	95	103	114	122	129	141	147	156	165	173
	0	82	87	91	105	114	126	135	143	156	165	173	184	192
	1	88	93	103	114	131	146	157	168	180	191	201	212	223
	2	98	104	115	132	147	164	181	192	208	219	236	247	264
	3	109	115	132	147	161	186	199	214	231	247	265	281	298
4	125	132	151	170	185	215	228	246	266	284	304	323	343	
100	S	77	80	88	99	108	119	128	135	147	155	163	173	181
	0	86	89	96	109	118	132	141	150	164	173	181	192	201
	1	91	97	109	121	137	154	165	178	188	201	213	224	236
	2	104	109	123	140	156	174	191	203	221	233	249	262	280
	3	115	123	141	159	172	199	212	228	247	266	284	301	318
4	132	141	162	182	197	228	243	262	284	306	326	346	366	
110	S	79	84	90	103	112	124	133	141	154	162	171	181	189
	0	89	93	100	114	124	137	147	156	171	180	189	201	210
	1	96	102	114	126	144	161	173	186	199	210	224	237	248
	2	109	116	129	147	165	184	202	214	233	247	265	278	297
	3	122	129	147	168	183	209	226	243	264	282	301	320	339
4	140	149	170	193	210	241	260	280	303	325	346	368	390	
120	S	83	88	94	108	116	129	137	146	161	170	179	188	198
	0	91	96	104	119	129	143	153	163	178	188	198	209	220
	1	100	107	119	132	151	168	181	195	208	222	236	248	261
	2	115	122	136	155	174	193	212	227	246	261	279	294	313
	3	129	136	157	179	193	222	239	258	280	299	319	341	361
4	149	157	181	205	222	256	275	297	322	344	367	391	414	
130	S	87	90	98	112	121	134	143	153	166	176	185	196	207
	0	95	100	109	124	134	147	159	170	185	195	207	219	228
	1	105	110	125	138	159	175	188	204	219	231	247	260	275
	2	121	129	144	164	183	203	223	238	259	275	294	309	329
	3	135	144	166	188	204	233	251	271	296	317	338	360	381
4	155	166	192	216	235	268	289	312	340	364	388	413	437	
PG		40	50	60	70	80	90	100	110	120	130	140	150	160



The prices in the basic table apply to models: **P1400N, P1414N, P1415N, P1415N BIS** with profiles in lacquered white, structured white and silver anodized. Surcharges for other models and profiles in other colors can be found on page 08.

BASIC PROGRAM

BASIC PROGRAM

		WIDTH												
PG		40	50	60	70	80	90	100	110	120	130	140	150	160
140	S	89	93	102	115	125	138	147	159	173	183	193	204	214
	0	98	104	113	129	140	154	165	176	192	203	214	227	239
	1	109	116	129	144	165	183	198	213	228	242	258	271	287
	2	126	134	151	172	192	213	233	248	270	287	308	326	346
	3	141	151	174	198	215	246	266	287	310	333	355	380	402
150	4	162	173	200	227	247	283	306	330	357	383	409	436	461
	S	91	96	105	119	129	144	154	164	180	189	201	212	223
	0	102	108	117	133	144	160	171	183	200	210	222	236	247
	1	114	121	135	151	172	191	205	222	238	252	269	285	299
	2	132	140	159	180	201	223	245	261	284	303	324	342	364
160	3	147	159	183	208	227	258	278	301	327	351	373	398	422
	4	170	182	210	239	261	297	320	346	376	404	429	457	485
	S	94	99	109	124	135	147	160	171	186	196	208	220	230
	0	105	110	121	137	150	165	178	189	207	219	230	245	257
	1	118	125	141	156	179	198	213	230	247	264	281	297	312
170	2	137	146	165	188	209	231	256	271	297	315	338	356	380
	3	154	165	191	218	238	268	290	315	344	367	392	418	443
	4	177	191	219	250	273	308	334	363	395	423	451	480	509
	S	97	103	113	128	140	153	165	176	192	204	215	227	240
	0	109	114	125	142	154	171	183	195	213	227	239	252	266
180	1	122	129	146	162	185	205	221	240	258	275	291	307	325
	2	143	152	172	195	219	242	266	285	308	328	352	372	395
	3	161	172	200	227	248	281	305	329	361	385	410	438	462
	4	185	197	229	261	285	323	350	378	414	443	471	503	532
	S	100	107	116	132	144	159	171	182	199	210	223	236	247
190	0	112	117	129	146	160	176	188	202	221	234	247	262	276
	1	126	134	152	168	192	212	228	248	267	285	304	320	336
	2	147	159	180	203	227	251	277	296	323	344	367	389	412
	3	168	180	208	237	260	291	318	345	375	403	428	457	485
	4	193	206	239	271	299	335	366	396	432	464	492	525	557
200	S	103	109	119	136	147	163	175	188	205	218	229	243	257
	0	114	121	133	151	165	181	195	208	227	242	256	270	285
	1	131	140	156	174	200	220	238	258	278	294	314	332	350
	2	154	164	186	212	237	262	287	306	334	356	383	405	429
	3	174	186	217	247	270	305	331	360	391	419	447	477	504
210	4	200	215	248	284	311	350	381	413	450	482	513	549	580
	S	107	112	124	140	153	168	181	194	212	224	238	250	265
	0	117	124	137	155	170	186	201	215	236	249	264	279	293
	1	135	144	162	181	207	227	246	267	287	306	326	345	363
	2	160	170	193	220	246	270	298	319	346	371	396	420	446
220	3	181	193	226	257	282	315	345	373	408	436	464	496	524
	4	208	222	260	294	325	363	396	429	469	501	534	571	603
	S	109	115	128	144	157	173	186	200	218	230	245	259	271
	0	121	128	142	160	175	192	208	222	242	257	271	287	304
	1	140	147	168	186	213	234	252	276	297	315	338	356	374
230	2	165	176	201	227	255	281	307	329	361	385	411	436	462
	3	188	201	233	267	293	327	357	387	424	453	482	516	545
	4	216	231	268	307	336	376	411	446	488	521	555	594	627
	S	112	118	132	147	162	179	192	205	224	239	251	267	281
	0	124	131	145	165	180	198	213	228	248	265	280	297	312
240	1	144	153	173	192	220	242	261	284	306	326	348	367	387
	2	171	182	208	236	264	290	319	342	372	398	425	451	479
	3	194	208	242	276	305	341	371	403	439	470	501	535	565
	4	223	239	279	317	350	391	427	464	506	540	577	615	650
	S	115	122	135	153	166	183	198	212	230	246	260	276	288
250	0	128	135	150	170	185	203	219	236	257	271	288	306	322
	1	147	157	179	199	227	248	268	291	317	336	361	381	401
	2	176	188	215	243	271	301	329	353	385	412	440	468	496
	3	201	215	249	286	315	351	385	417	456	487	519	555	586
	4	231	247	287	329	363	404	443	479	524	559	597	638	675
260	S	117	124	138	156	172	188	203	218	238	251	267	284	298
	0	131	138	154	174	191	208	226	242	264	280	297	314	329
	1	153	163	183	204	234	257	278	301	326	346	371	392	413
	2	182	194	222	251	281	310	341	365	398	425	456	485	513
	3	208	222	259	296	326	364	398	431	471	504	538	574	606
4	239	256	298	340	375	418	457	496	541	580	619	660	698	

BASIC PROGRAM



How to consider the extra charges which depends to the width or height of the pleated blind? **It's easy!**
E.g. **P1410N** with ordering width 849 mm:
(0,9 m x 15 €) = 13,50 €

EXTRA CHRGES



HANDLE OPERATION

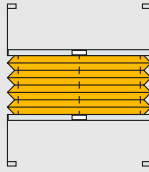

P1415N
Open at both sides - upwards and downwards.

NO EXTRA CHARGES

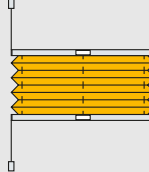

P1414N
Open at both sides - upwards and downwards, mounted on non-invasive window frame clamp.

NO EXTRA CHARGES

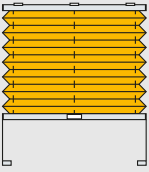

P1400N
Open at both sides - upwards and downwards.

NO EXTRA CHARGES

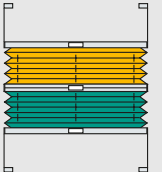

P1415N BIS 
Double fabric, open at both sides - upwards and downwards.

NO EXTRA CHARGES

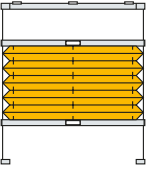

P1410N
Open at both sides - upwards and downwards, with top fixed profile.

15,00 €/prm
from blind's width

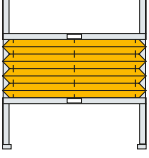

P1416N
Opened on both sides - upwards and downwards with slats for non-invasive mounting on the window glass.

height	extra charge
to 100 cm	47,00 €
from 100,1 to 150 cm	64,00 €
from 150,1 to 200 cm	81,00 €
from 200,1 to 220 cm	92,00 €

TILT & TURN WINDOWS



HANDLE OPERATION

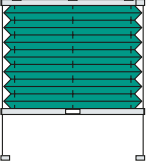

P2400N
Open at one side - downwards, with top fixed profile.

28,00 €

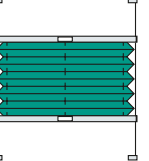

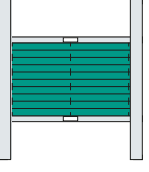

P2415N
Open at both sides - upwards and downwards

28,00 €



P2416N
Open at both sides - upwards and downwards, with side covering profiles.

Colours of covering profiles:
 

height	extra charge
to 100 cm	51,00 €
from 100,1 to 120 cm	56,00 €
from 120,1 to 140 cm	60,00 €

ROOF WINDOWS

SURCHARGE FOR NON-STANDARD COLORS

							
OFF WHITE STRUCTUR	CREME STRUCTUR	BEIGE POWDER COATED	BRONZE ANODISED	GREY STRUCTUR	DARK GREY POWDER COATED	ANTHTACITE* STRUCTUR	BLACK STRUCTUR

	WIDTH												
	40	50	60	70	80	90	100	110	120	130	140	150	160
€	3,5	4,4	5,3	6,2	7,0	7,9	8,9	9,7	10,5	11,5	12,3	13,2	14,1

* Components (mounting feet, handles, side caps) in black

BASIC PROGRAM

EXTRA CHARGE

SURCHARGE FOR PLUS PROFILE*

	WIDTH													
	40	50	60	70	80	90	100	110	120	130	140	150	160	
€	3,5	4,3	5,2	6,0	6,9	7,7	8,5	Reinforced profile used regular						

IMPORTANT: For widths of 1.00 m and over, a 20 x 22 mm reinforced profile is used as standard. It is possible to order a pleated blind with a width of less than 1.00 m with a reinforced profile for an extra charge according to the table above.

Price estimation step by step



Data for estimation of a sample roller-blind price are marked in red.

For the purposes of the calculation, we used following parameters:

Measurements: 78,6 cm x 142 cm
Model - P1410N (mit Zusatzprofil)
Fabric - S-0150 PL (PG-S)
Extra charge - „METALLGRIFF“

- 1 Take the measurements e.g. 78,6 cm x 142 cm (width x height)
- 2 Find the price in the price table, according to both: measurements rounded up and price group (PG) of a chosen fabric, e.g. (80 cm x 150 cm **129 €**)
- 3 Choose a suitable model, e.g. (p. 08) + extra charge for width (0.80 x 15 € = **12 €**)
- 4 Choose the additionally: „METALLGRIFF“ 2 pc. (2 x 8 € = **16 €**)
- 5 Recommended retail price including VAT (129 € + 12 € + 16 € = **157 €**)

Did you know that?



Is it possible to manufacture pleated blinds with dimensions larger than those specified in the basic table? It is possible to connect the fabric panels (fabric overlap). If you have any questions, please contact our Customer Service

*instead of a regular reinforced profile

DECOMATIC® COMFORT



Important

You will find detailed information on components and pleated blind systems constructions in the product brochure. The brochure is also available in the digital version on our website.



Informations

- 1 Standard elements used for fixing are mounting feet or clips. With a ready-made pleated blind you will receive a set of standard mounting parts necessary for mounting a certain pleated blind model.
- 2 For pleated blinds wider than 1,10 m a PLUS profile 20 x 22 mm (width x height) is used instead of standard profile (16 mm height). It is possible to order pleated blinds with a width of less than 1.00 m with a reinforced profile for a surcharge according to the surcharge table on page 9 - simply tick the appropriate box on the order form.
- 3 The models marked with symbols **P1615 BIS, P1620, P1622, P1626, P1720, P1722, P1725, P1820, P1822, P1825, P1920, P1922, P1925, P2620, P2622, P2626**, consist of two fabrics. To calculate the price of such a pleated blind summarise the basic pleated blind price with the first fabric and the basic pleated blind price with the second fabric, considering the fabric price group each time. This icon will remind you to take into account the second fabric in the pricing.
- 4 Maximum possible fabric widths are given in the fabric collection books. If a pleated blind exceeds this value, the fabric may require a vertical connection.
- 5 Profiles can be powder coated in any RAL colour (individual pricing). Other components (end caps, mounting parts) are available in standard colours.
- 6 The COMFORT range of pleated blinds with a grip uses internal springs to regulate the tension of the cords. The use of springs has a significant effect on the lightness and smoothness of pleated blind handling, and also, in case of a mistake or inaccurate height measurement, the springs level out the difference during installation, regardless of whether the difference in measurement was plus or minus the actual dimension.
- 7 At customer's request we can modify a previously produced pleated blind. Such a pricing is prepared by our Customer Service. Modification in a pleated blind is made according to the applicable technology (e.g. decrease of blind, replacement of fabric or cords).



Colours of the COMFORT profiles*

RAL 9016

WHITE
POWDER COATED

RAL 9016

WHITE
STRUCTUR

RAL 9010

OFF WHITE
STRUCTUR



BRONZE
ANODISED

RAL 1015

BEIGE
POWDER COATED

RAL 9001

CREME
STRUCTUR

RAL 7040

GREY
STRUCTUR

E6/EV1

SILVER
ANODISED

RAL 7016

ANTHTACITE**
STRUCTUR

DB 703

DARK GREY
POWDER COATED

RAL 9005

BLACK
STRUCTUR

COMFORT PROGRAM

BASIC TABLE

Recommended retail prices including VAT

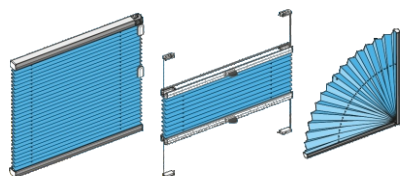

! Maximum production dimensions for each model are specified in the product brochure.

■ Check it out!

Mounting parts*: mounting feet, clips, block holders, adjustable brackets.

Types of operation*: handle, cord, chain or electric motors operation

*depending on a pleated blind model. Detailed information in the product brochure and fabric catalogue.

		WIDTH																		
PG		40	50	60	70	80	90	100	110	120	130	140	150	160	170	180	190	200	210	220
70	S	79	83	87	100	109	120	129	136	149	157	164	175	182	192	199	208	217	225	238
	0	87	92	98	112	119	134	143	151	165	175	182	193	202	213	222	230	242	250	264
	1	92	97	109	119	136	153	164	176	188	198	209	221	231	243	259	271	282	294	304
	2	101	109	118	136	152	169	185	197	213	225	242	254	270	281	297	309	326	337	354
	4	112	118	134	151	163	191	202	218	236	252	269	285	303	320	336	346	362	380	402
80	S	81	85	91	103	111	125	132	140	153	162	169	179	188	198	206	213	224	232	245
	0	91	94	100	114	124	139	146	156	171	179	189	199	209	221	229	238	249	258	272
	1	94	100	112	124	142	158	171	182	193	205	216	228	241	252	270	281	293	304	315
	2	106	112	124	142	158	176	193	205	223	234	252	263	281	293	310	322	340	352	369
	4	116	124	142	158	171	199	211	228	245	263	281	298	315	334	352	362	380	399	421
90	S	84	88	94	109	117	130	139	146	160	169	178	189	197	209	216	225	237	244	258
	0	93	98	104	119	130	144	153	163	178	189	197	210	218	231	241	250	262	272	288
	1	99	106	117	130	149	166	179	192	205	217	229	242	255	267	285	297	310	323	336
	2	112	118	131	150	167	188	206	218	237	249	269	281	301	313	330	344	362	375	395
	4	124	131	150	169	183	212	226	244	264	282	302	321	340	359	377	390	409	428	453
100	S	87	92	99	113	123	136	145	153	167	177	185	197	206	218	228	237	248	257	271
	0	97	101	110	125	134	150	160	171	188	197	206	218	229	243	254	263	276	285	302
	1	104	111	124	137	157	176	189	202	215	229	243	256	269	282	302	315	328	342	355
	2	118	125	140	159	178	198	217	231	252	265	285	298	320	334	353	367	387	401	422
	4	131	140	160	180	196	226	242	261	282	303	323	343	362	385	405	419	439	459	486
110	S	91	96	103	117	127	142	151	160	176	184	195	206	216	229	238	248	259	270	283
	0	100	106	114	130	142	157	167	178	195	205	216	229	241	255	264	275	289	298	315
	1	110	116	130	144	164	183	197	212	226	241	256	270	283	297	318	331	346	360	375
	2	125	132	147	167	189	210	230	244	265	281	302	317	339	354	374	389	409	425	448
	4	139	147	169	192	209	239	257	277	301	322	343	366	387	408	432	447	469	491	518
120	S	94	99	107	123	132	146	157	166	183	193	204	215	225	239	249	259	271	281	297
	0	104	110	118	136	146	163	175	185	202	213	225	239	250	265	276	288	302	313	330
	1	114	120	136	150	172	192	206	223	238	254	269	283	297	314	335	348	366	379	395
	2	131	139	156	177	198	221	242	258	280	297	318	336	357	374	395	412	434	451	474
	4	146	156	179	204	221	254	272	294	320	341	363	388	410	434	458	475	499	521	550
130	S	98	103	112	127	137	152	163	175	190	201	211	224	236	249	259	271	283	294	310
	0	109	114	124	142	152	169	180	193	211	223	236	249	261	276	289	301	314	327	344
	1	119	126	143	158	180	199	215	232	249	264	281	296	313	329	350	367	383	399	415
	2	137	146	164	188	209	231	255	271	295	313	336	354	376	394	418	435	456	475	501
	4	153	164	190	213	232	265	288	310	337	361	386	409	434	459	485	504	528	552	583
PG		40	50	60	70	80	90	100	110	120	130	140	150	160	170	180	190	200	210	220



The prices from the basic table refer to the models:
with handle P1600, P1614, P1615, P1615BIS, P1620,
with cord P1700, P1720,
and all permanently mounted pleated blinds.

Extra charges for remaining models you will find on page 14-20.



Extra charges for models with electric motors on page 18.

Extra charges for **electric motors and controls** on page 45-50

COMFORT PROGRAM

		WIDTH																		
PG		40	50	60	70	80	90	100	110	120	130	140	150	160	170	180	190	200	210	220
140	S	100	106	116	131	143	158	169	180	197	209	221	232	244	259	271	282	295	307	323
	0	112	118	129	146	159	176	189	201	218	231	244	259	272	288	301	313	328	341	359
	1	125	132	147	164	189	209	225	243	261	276	294	310	327	344	367	383	401	418	435
	2	144	152	172	196	218	243	265	283	309	328	353	372	395	415	438	456	481	500	528
	3	160	172	198	225	245	280	303	327	355	380	406	433	458	485	512	532	558	584	615
4	184	198	228	259	282	321	349	376	408	437	467	498	526	558	589	612	642	671	707	
150	S	104	110	119	136	147	164	176	188	205	216	229	242	255	270	281	293	307	320	336
	0	116	123	133	151	164	182	195	209	228	241	254	269	282	298	313	326	341	354	373
	1	130	137	153	172	196	217	234	254	271	289	308	324	341	360	383	400	419	435	454
	2	150	159	180	205	229	255	278	297	323	344	369	389	415	435	459	480	505	525	554
	3	167	180	209	237	258	294	317	343	374	401	426	454	481	508	537	560	587	615	646
4	193	208	240	273	297	338	365	395	430	461	490	522	553	585	617	644	676	707	743	
160	S	107	113	125	142	153	169	182	195	212	224	237	250	263	280	293	304	320	330	348
	0	119	126	137	157	171	189	202	216	236	249	263	278	293	310	324	339	354	368	388
	1	134	143	160	178	204	225	243	263	282	301	321	339	356	375	400	418	436	454	474
	2	157	166	189	213	239	264	291	310	339	360	386	407	433	455	481	502	528	550	582
	3	176	189	217	248	271	307	331	360	392	420	448	477	505	534	564	587	618	645	679
4	202	217	250	285	312	353	381	414	450	483	515	548	581	614	648	676	711	742	781	
170	S	111	117	129	145	159	175	189	201	218	232	245	259	274	290	303	315	330	343	361
	0	124	130	143	162	176	195	209	223	243	258	272	289	303	322	336	352	368	382	402
	1	139	147	166	184	211	234	252	274	294	313	334	352	370	390	416	434	454	473	493
	2	163	173	196	223	249	276	303	324	353	375	402	425	452	475	502	525	552	574	607
	3	183	196	228	258	283	321	347	376	410	439	468	500	528	560	590	616	648	677	711
4	210	225	262	297	326	369	399	433	472	505	539	575	608	644	678	708	745	779	818	
180	S	114	120	132	150	164	180	195	208	226	241	255	269	282	301	313	327	342	356	375
	0	127	133	147	166	182	201	215	230	252	267	282	298	314	334	348	363	380	395	416
	1	144	152	173	192	218	242	261	283	306	324	346	366	385	407	432	451	473	492	514
	2	169	180	205	231	259	288	315	337	368	392	420	444	471	497	523	547	574	599	635
	3	191	205	237	270	296	334	362	393	428	459	488	521	552	585	617	644	677	708	743
4	220	236	273	311	340	384	416	452	492	528	562	600	635	673	709	741	779	814	855	
190	S	117	124	136	156	169	185	199	215	234	248	262	277	293	310	324	339	354	368	388
	0	130	137	151	172	189	206	223	238	259	276	291	309	324	344	360	376	393	409	432
	1	149	159	178	198	228	250	271	294	317	336	359	379	400	422	448	468	491	512	533
	2	176	188	212	242	270	298	327	350	382	407	436	461	490	517	545	570	599	624	662
	3	198	212	247	281	309	347	377	409	447	478	510	545	574	610	644	672	708	737	776
4	228	244	284	323	355	399	434	471	514	549	586	627	661	701	741	773	814	848	893	
200	S	120	127	142	159	175	192	206	222	242	256	271	287	302	321	335	350	367	380	401
	0	133	142	157	177	193	212	229	245	269	285	301	318	335	356	373	389	407	422	445
	1	153	164	184	206	236	258	280	304	327	348	372	393	413	438	465	485	508	530	553
	2	182	193	221	250	280	309	340	363	395	423	453	480	508	536	566	593	622	649	688
	3	206	221	257	293	322	360	393	426	466	498	531	566	599	635	670	701	736	769	808
4	237	254	296	336	370	414	452	490	536	572	610	651	689	730	770	806	846	884	929	
210	S	124	131	145	164	179	197	212	228	248	263	278	295	310	330	346	361	377	393	413
	0	137	145	162	182	199	218	237	254	276	293	310	328	346	368	385	401	420	436	459
	1	159	169	191	212	243	267	289	314	339	360	386	407	427	453	481	502	526	548	573
	2	189	201	229	259	290	321	352	376	410	439	469	498	528	556	587	616	646	675	715
	3	213	229	265	304	335	374	408	442	484	518	551	589	623	661	697	729	766	800	840
4	246	263	305	350	385	430	469	509	556	595	633	677	716	760	802	838	880	920	966	
220	S	127	134	150	169	184	204	218	234	256	272	288	306	321	341	356	373	389	406	426
	0	142	149	165	189	205	225	243	261	283	302	320	339	356	379	395	413	433	451	474
	1	164	175	197	218	250	276	297	323	350	372	399	420	442	468	497	519	545	567	593
	2	195	208	237	269	301	331	363	389	425	454	486	515	547	577	607	638	669	699	742
	3	222	237	276	314	347	388	423	459	501	537	572	611	646	685	724	757	796	830	873
4	255	273	317	361	399	446	487	528	577	617	658	703	743	788	833	871	916	955	1004	
230	S	131	139	153	175	190	209	225	242	263	280	296	314	329	352	368	385	401	418	439
	0	145	153	171	193	211	231	249	269	293	310	329	348	367	389	408	426	445	465	488
	1	169	179	204	226	258	283	307	334	361	385	410	434	456	484	513	536	563	586	613
	2	201	213	245	277	310	343	376	403	439	471	502	534	566	597	630	661	694	724	768
	3	229	245	285	326	360	401	439	475	520	556	593	633	670	710	750	784	826	862	905
4	263	282	328	374	414	461	505	547	598	639	682	728	770	817	863	902	950	992	1040	
240	S	133	142	158	178	196	213	231	248	271	288	304	323	340	361	377	395	413	431	453
	0	149	158	176	198	217	238	257	276	301	320	339	359	376	401	420	439	459	478	502
	1	175	185	209	232	267	293	317	343	372	395	423	448	472	500	530	553	582	604	632
	2	208	222	254	288	321	355	388	416	454	486	520	552	585	617	651	683	717	749	795
	3	237	254	295	337	373	415	454	492	538	577	615	655	694	735	777	813	855	893	937
4	273	292	339	388	429	477	522	566	619	663	707	753	798	845	894	935	983	1027	1077	

COMFORT PROGRAM

		WIDTH																		
PG		40	50	60	70	80	90	100	110	120	130	140	150	160	170	180	190	200	210	220
250	S	137	145	162	183	201	221	238	255	277	295	313	331	348	372	389	407	425	442	466
	0	152	162	180	204	223	244	263	283	309	328	347	368	388	412	433	452	472	491	517
	1	179	191	215	239	275	301	326	354	383	408	436	461	486	515	546	570	599	623	652
	2	213	228	261	296	330	366	401	431	468	501	537	570	604	637	672	707	741	774	822
	3	243	261	306	348	386	427	469	508	556	596	635	678	717	761	804	842	886	924	970
260	4	279	300	351	400	444	491	540	585	639	685	730	780	825	875	925	969	1019	1062	1115
	S	140	149	166	189	206	225	243	262	285	303	322	341	359	382	400	418	436	454	478
	0	157	165	184	209	229	250	271	291	317	337	357	377	399	423	444	465	485	505	532
	1	184	196	222	247	282	309	335	363	394	420	449	474	500	531	561	586	617	643	671
	2	221	236	270	306	341	376	412	442	484	518	553	587	623	658	694	729	764	799	848
270	3	250	270	314	359	399	441	485	525	574	616	655	701	741	786	830	871	914	955	1001
	4	288	311	361	412	458	507	558	604	661	708	753	806	852	903	955	1001	1051	1099	1152
	S	144	152	171	192	211	231	249	269	293	311	329	350	368	392	410	428	449	467	491
	0	160	169	190	213	234	257	277	297	324	346	367	388	408	435	455	477	499	519	546
	1	189	201	228	254	290	318	343	374	406	432	464	488	515	546	578	604	635	662	692
280	2	226	242	277	314	352	388	425	455	498	533	570	605	643	678	715	750	788	823	875
	3	258	277	324	370	410	454	500	541	593	635	677	723	764	810	858	898	944	986	1033
	4	297	319	373	426	472	522	575	623	682	730	779	832	879	932	986	1032	1085	1134	1188
	S	147	157	175	197	216	237	256	275	301	320	339	359	377	402	421	440	460	480	504
	0	163	173	195	218	241	263	283	306	334	355	376	399	420	447	468	490	512	533	560
PG	1	193	206	234	261	297	326	353	385	418	444	475	502	530	561	594	620	652	679	712
	2	232	248	287	323	361	400	436	469	512	550	586	623	662	698	736	774	812	848	902
	3	265	287	334	382	423	468	515	558	611	653	697	745	788	836	883	926	974	1017	1066
	4	305	330	384	439	487	539	593	642	703	751	802	857	906	962	1016	1065	1120	1169	1226
	PG	40 <th>50</th> <th>60</th> <th>70</th> <th>80</th> <th>90</th> <th>100</th> <th>110</th> <th>120</th> <th>130</th> <th>140</th> <th>150</th> <th>160</th> <th>170</th> <th>180</th> <th>190</th> <th>200</th> <th>210</th> <th>220</th>	50	60	70	80	90	100	110	120	130	140	150	160	170	180	190	200	210	220

Did you know that?

In the production of pleated blind we rely on the leading in Europe system DECOMATIC® of German company BENTHIN. This system guarantees the highest quality of details and modern solutions, translating into reliable use for many years.

Price estimation step by step

For the purposes of the calculation, we used following parameters:

Dimensions - 87,5 cm x 109,3 cm
Model - P1705
Fabric - 1-1350 PL (PG: 1)
Extra charge - mounting feet for windows with narrow glazing bead

1

Take a measurement, 87,5 cm x 109,3 cm (width x height)

2

Find the price in the price table, according to both: measurements rounded up and price group (PG) of a chosen fabric, e.g. 90 cm x 110 cm (183 €)

3

Choose the model of pleated blind (page 14-20) P1705 (extra charge for the model 28,00 €)

4

Additional option: mounting feet for windows with narrow glazing beads 1 set (2,40 €)

5

Recommended retail price including VAT (183 € + 28 € + 2,40 €) **213,46 €**

COMFORT PROGRAM

1/2

Models **P1615 BIS**, **P1620**, **P1622**, **P1626** are double fabric models. Please remember to add prices for both fabrics considering their price groups for the full size of the pleated blind.

EXTRA CHARGES



HANDLE OPERATION

P1615
Open at both sides - upwards and downwards.

NO EXTRA CHARGES

P1614
Open at both sides - upwards and downwards, mounted on non-invasive window frame clamp.

NO EXTRA CHARGES

P1600
Open at one side - upwards, with top fixed profile

NO EXTRA CHARGES

P1615 BIS ^{1/2}
Double fabric, open at both sides - upwards and downwards.

NO EXTRA CHARGES

P1620 ^{1/2}
Double fabric, open at one side - upwards.

NO EXTRA CHARGES

P1602
Open at one side - downwards, with top and bottom fixed profile

16,00 € /prm.
of a blind's width

P1610
Open at both sides - upwards and downwards, with top fixed profile.

16,00 € /prm.
of a blind's width

P1612
Open at both sides - upwards and downwards, with top and bottom fixed profile.

29,00 € /prm.
of a blind's width

P1616
Opened on both sides - upwards and downwards, with slats for non-invasive mounting on the glass.

P1622 ^{1/2}
Double fabric, open at one side - upwards with top fixed profile.

16,00 € /prm.
of a blind's width

P1626 ^{1/2}
Double fabric, upper and lower fabric operated independently, with top and bottom fixed profile.

16,00 € /prm.
of a blind's width

Height	Extra charge
from 100 cm	47,00 €
from 100,1 to 150 cm	64,00 €
from 150,1 to 200 cm	81,00 €
from 200,1 to 220 cm	90,00 €

P1634
Special form: trapezoid with one-sided slant, open at one side - downwards.

130,00 € /m2
(min. 100,00 €)

P1635
Special form: trapezoid with double-sided slant, open at one side - downwards.

210,00 € /m2
(min. 210,00 €)

P1636
Special form: triangle with one-sided slant, open at one side.

130,00 € /m2
(min. 100,00 €)

TILT & TURN WINDOWS

SURCHARGE FOR REINFORCED PROFILE:

	WIDTH												
	40	50	60	70	80	90	100	110	120	130	140	150	160
€	3,5	4,3	5,2	6,0	6,9	7,7	8,5	9,4	Reinforced profile used regular				



IMPORTANT:

For widths of 1.00 m and over, a 20 x 22 mm reinforced profile is used as standard. It is possible to order a pleated blind with a width of less than 1.00 m with a reinforced profile for an extra charge according to the table above.

EXTRA CHARGES

COMFORT PROGRAM



HANDLE OPERATION

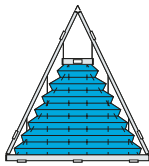

P1637
Special form:
triangle with
double-sided slant,
open at one side -
downwards.
210,00 /m2
(min. 210,00 €)

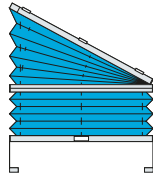

P1650
Special form:
open at one side
- upwards.
Only rectangular part
is moveable.
130,00 € /m2
(min. 100,00 €)

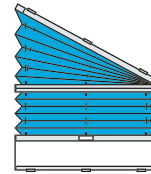

P1652
Special form:
open at one
side - upwards,
with middle and
bottom fixed profile
130,00 € /m2
+ **16,00 € /prm.**
of a blind's width

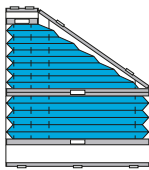

P1660
Special form:
open at both sides -
upwards and
downwards.
210,00 /m2
(min. 210,00 €)

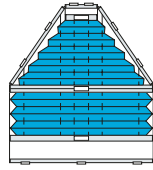

P1661
Special form:
open at both sides -
upwards and
downwards.
210,00 € /m2
(min. 210,00 €)

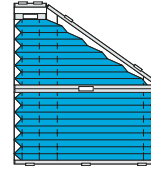

P1662
Special form:
open at one
side - downwards.
210,00 € /m2
(min. 210,00 €)

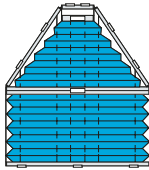

P1663
Special form:
open at one
side - downwards.
210,00 € /m2
(min. 210,00 €)

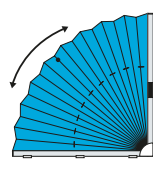

P1680
Special form:
open at one
side.
210,00 € /m2
(min. 210,00 €)

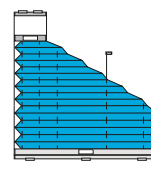

P1682
Special form:
open at both sides -
upwards and
downwards.
210,00 € /m2
(min. 210,00 €)

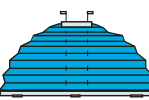

P1686
Special form:
open at one
side - downwards.
130,00 € /m2
(min. 100,00 €)

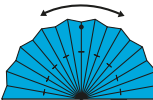

P1687
Special form:
open at one
side.
130,00 € /m2
(min. 100,00 €)

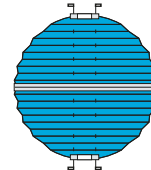

P1688
Special form:
open at both sides -
upwards and
downwards.
210,00 € /m2
(min. 210,00 €)

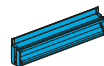

OPERATION VIA GRIP PROFILE

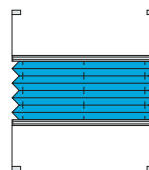

P5615
Opens both sides -
upwards and downwards
44,00 €
54,00 € /rm of
system width

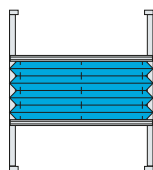

P5616
Opens both sides -
upwards and downwards
45,00 €
54,00 € /rm of
system width

Height from to	Extra charge
from 100 cm	47,00 €
from 100,1 to 150 cm	64,00 €
from 150,1 bis 200 cm	81,00 €
von 200,1 bis 220 cm	90,00 €

Operation-profile colour

RAL 9016 WHITE POWDER COATED

E6/EV1 SILVER ANODISED

RAL 7016 ANTHRACITE STRUKTUR

E6 C35 BLACK ANODISED

COMFORT PROGRAM



How to consider the extra charges which depends to the width or height of the pleated blind? **It's easy!**
E.g. P1702 with ordering width 1290 mm:
(1,30m x 16 €) + 28 € (side guiding) = 48,80 €

EXTRA CHARGES



CORD OPERATION

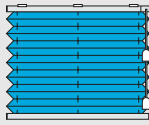

P1700
Open at one side - upwards.

NO EXTRA CHARGES

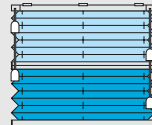

P1720 ^{1/2}
Double fabric open of one side - upwards.

NO EXTRA CHARGES

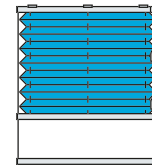

P1702
Open at one side - upwards, with top and bottom fixed profile.

28,00 €
+ 18,00 € /prm.
of a blind's width

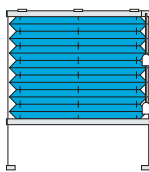

P1705
Open at one side - upwards, with top fixed profile and side guiding.

28,00 €

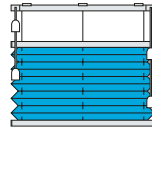

P1710
Open at both sides - upwards and downwards, with top fixed profile.

17,00 €
+ 16,00 € /prm.
of a blind's width

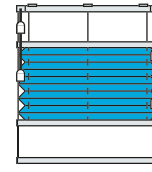

P1712
Open at both sides - upwards and downwards, with top and bottom fixed profile.

43,00 €
+ 28,00 € /prm.
of a blind's width

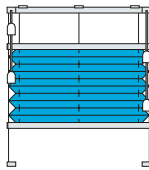

P1715
Open at both sides - upwards and downwards, with top fixed profile and side guiding.

43,00 €
+ 16,00 € /prm.
of a blind's width

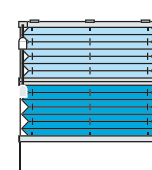

P1722 ^{1/2}
Double fabric, open at one side - upwards, with top and bottom fixed profile.

28,00 €
+ 16,00 € /prm.
of a blind's width

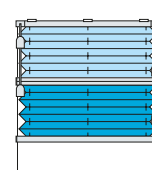

P1725 ^{1/2}
Double fabric, open at one side - upwards, with top fixed profile and side guiding.

28,00 €

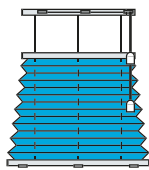

P1730
Special form: trapezoid with double-sided slant, open at one side - downwards.

105,00 € /m2
(min. 77,00 €)

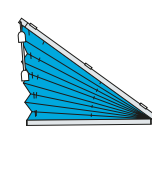

P1740 ^B
Special form: triangle with one-sided slant, open at one side - upwards.

130,00 € /m2
(min. 100,00 €)

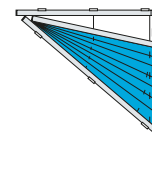

P1741
Special form: triangle with one-sided slant, open at one side - downwards.

130,00 € /m2
(min. 100,00 €)

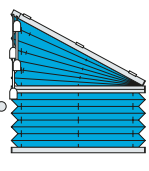

P1750
Special form: open at one side - upwards, with top fixed profile.

105,00 € /m2
(min. 77,00 €)

WITHOUT CORD BREAK

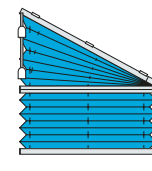

P1751
Special form: open at one side - upwards, with top fixed profile.

105,00 € /m2
(min. € 77,00)

WITH CORD BREAK

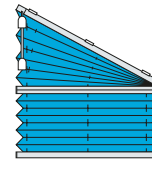

P1753 ^B
Special form: open at one side - upwards, with top fixed profile.

105,00 € /m2
(min. € 77,00)

WITH CORD BREAK

TILT & TURN WINDOWS

1/2

Models **P1720**, **P1722** and **P1725** are double fabric models. Please remember to add prices for both fabrics considering their price groups for the full size of the pleated blind.

EXTRA CHARGES

COMFORT PROGRAM



CHAIN OPERATION

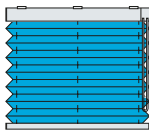

P1800
Open at one side - upwards, with top fixed profile.

63,00 €
+ 30,00 € /prm.
of a blind's width

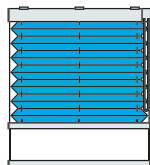

P1802
Open at one side - upwards, with top and bottom fixed profile.

90,00 €
+ 46,00 € /prm.
of a blind's width

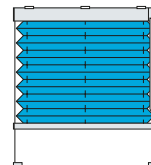

P1805
Open at one side - upwards, with top fixed profile and side guiding.

90,00 €
+ 30,00 € /prm.
of a blind's width

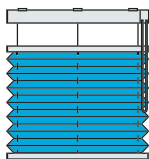

P1810
Open at both sides - upwards, and downwards with top fixed profile and side guiding.

63,00 €
+ 46,00 € /prm.
of a blind's width

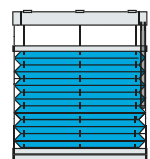

P1812
Open at both sides - upwards, and downwards with top and bottom fixed profile and side guiding. No possibility of independent control of movable middle profiles.

90,00 €
+ 58,00 € /prm.
of a blind's width

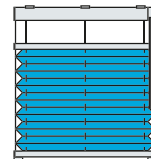

P1815
Open at both sides - upwards, and downwards with top fixed profile and side guiding.

90,00 €
+ 46,00 € /prm.
of a blind's width

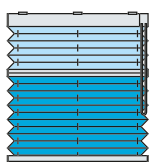

P1820 ^{1/2}
Double fabric, open at one side - upwards.

63,00 €
+ 30,00 € /prm.
of a blind's width

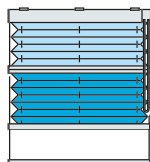

P1822 ^{1/2}
Double fabric, open at one side - upwards, with top and bottom fixed profile.

90,00 €
+ 30,00 € /prm.
of a blind's width

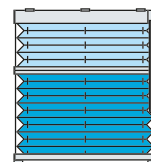

P1825 ^{1/2}
Double fabric, open at one side - upwards, with top fixed profile and side guiding.

90,00 €
+ 30,00 € /prm.
of a blind's width

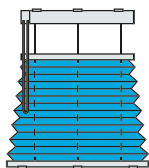

P1830
Special form: trapezoid with double-sided slant, open at one side - downwards.

63,00 €
+ 30,00 € /prm.
of a blind's width
+ 105,00€ /m2
(min. 77,00 €)

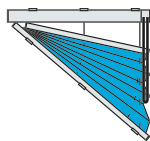

P1841
Special form: triangle with one-sided slant, open at one side - downwards.

63,00 €
+ 30,00 € /prm.
of a blind's width
+ 130,00€ /m2
(min. 100,00 €)

Models **P1820**, **P1822** and **P1825** are double fabric models. Please remember to add prices for both fabrics considering their price groups for the full size of the pleated blind.



TILT & TURN WINDOWS

COMFORT PROGRAM

COMFORT PROGRAM



How to consider the extra charges which depends to the width or height of the pleated blind? **It's easy!**
E.g. P1910 with ordering width 1350 mm:
(1,4m x 46 €) + 63 € = **127,40 €** (without electric motor)

EXTRA CHARGES

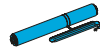

ELECTRIC MOTOR OPERATION

TILT & TURN WINDOWS

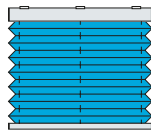

P1900

Open at one side - upwards, with top fixed profile.

63,00 €
+ **30,00 €** /prm. of a blind's width

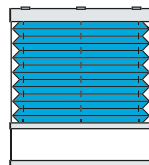

P1902

Open at one side - upwards, with top and bottom fixed profile.

90,00 €
+ **46,00 €** /prm. of a blind's width

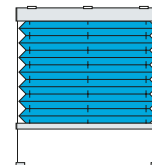

P1905

Open at one side - upwards, with top fixed profile and side guiding.

90,00 €
+ **30,00 €** /prm. of a blind's width

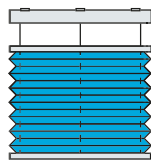

P1910

Open at both sides - upwards, and downwards with top fixed profile and side guiding.

63,00 €
+ **46,00 €** /prm. of a blind's width

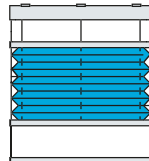

P1912

Open at both sides - upwards, and downwards with top and bottom fixed profile and side guiding.

90,00 €
+ **58,00 €** /prm. of a blind's width

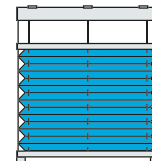

P1915

Open at both sides - upwards, and downwards with top fixed profile and side guiding.

90,00 €
+ **46,00 €** /prm. of a blind's width

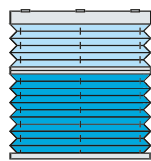

P1920 ^{1/2}

Double fabric, open at one side - upwards.

63,00 €
+ **30,00 €** /prm. of a blind's width

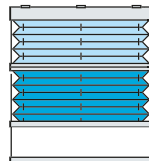

P1922 ^{1/2}

Double fabric, open at one side - upwards, with top and bottom fixed profile.

90,00 €
+ **30,00 €** /prm. of a blind's width

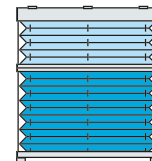

P1925 ^{1/2}

Double fabric, open at one side - upwards, with top fixed profile and side guiding.

90,00 €
+ **30,00 €** /prm. of a blind's width)

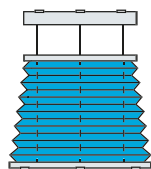

P1930

Special form: trapezoid with double-sided slant, open at one side - downwards.

63,00 €
+ **30,00 €** /prm. of a blind's width
+ **105,00 €** /m² (min. 87,00 €)

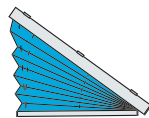

P1940

Special form: triangle with one-sided slant, open at one side - upwards.

63,00 €
+ **30,00 €** /prm. of a blind's width
+ **130,00 €** /m² (min. 100,00 €)

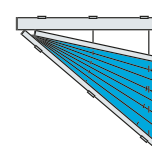

P1941

Special form: triangle with one-sided slant, open at one side - downwards.

63,00 €
+ **30,00 €** /prm. of a blind's width
+ **130,00 €** /m² (min. 100,00 €)

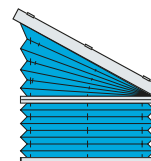

P1950

Special form: one-sided opening - upwards, with a fixed upper profile

90,00 €
+ **46,00 €** /Lfm. Anlagenbreite
+ **130,00 €** /m²

MOTORS:



LW25 - B83
24 V

195,00 €



TILT&LIFT
WireFree RTS
12 V

190,00 €



BREL BJE24D
0,8 Nm | 34 U / Min | 12 V

165,00 €



BREL BJE24TD
2x0,6 Nm | 34 U / Min | 12 V
P1910, P1912, P1915,
P1920, P1922, P1925

274,00 €



BREL BJE24TR
2x0,6 Nm | 34 U / Min | 12 V
P1950

308,00 €

EXTRA CHARGES

COMFORT PROGRAM

FIX MOUNTED PERMANENTLY

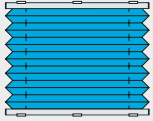

P1001
Mounted permanently.

NO EXTRA CHARGES

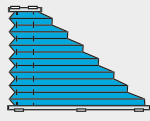

P1036
Special form: trapezoid with one-sided slant, mounted permanently.

NO EXTRA CHARGES

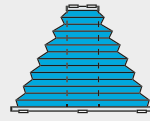

P1037
Special form: trapezoid with double-sided slant, mounted permanently.

NO EXTRA CHARGES

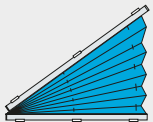

P1043
Special form: triangle with one-sided slant, mounted permanently.

NO EXTRA CHARGES

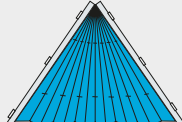

P1044
Special form: triangle with one-sided slant, mounted permanently.

NO EXTRA CHARGES

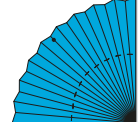

P1082
Special form: mounted permanently.

TABLE PRICE + 50%

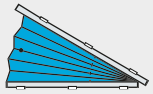

P1083
Special form: triangle with one-sided slant, mounted permanently.

NO EXTRA CHARGES

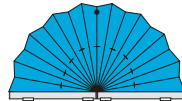

P1086
Special form: mounted permanently.

TABLE PRICE + 50%

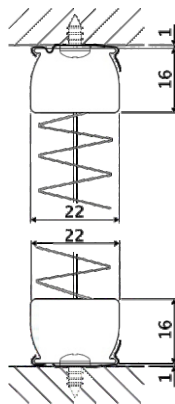

IMPORTANT:

Fixed profiles are mounted with mounting clips.
In the models **P1082** and **P1086** it is possible to make the pleated blind with handle operation and movable profiles.

COMFORT PROGRAM

EXTRA CHARGES



HANDLE OPERATION

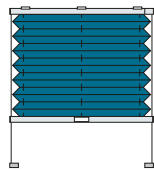

P2600
Open at one side - upwards, with top fixed profile.

28,00 €

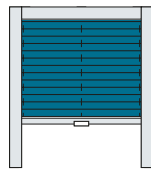

P2601
Open at one side with side covering profiles and top covering profile.

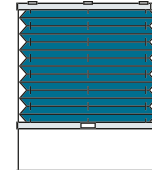

P2602
Open at one side - upwards, with top and bottom fixed profile.

42,00 €

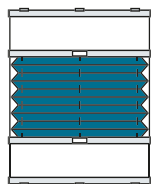

P2612
Open at one side, with top and bottom fixed profile

51,00 €

Width	Extra charge
from 100 cm	74,00 €
from 100,1 to 120 cm	77,00 €
from 120,1 to 140 cm	83,00 €

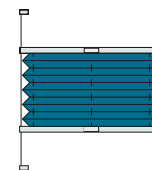

P2615
Open at both sides - upwards, and downwards

28,00 €

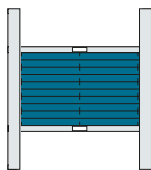

P2616
Open at both sides - upwards, and downwards, with side covering profiles.

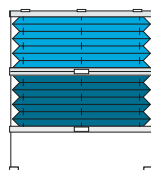

P2620 ^{1/2}
Double fabric, open at one side - upwards, with top fixed profile

28,00 €

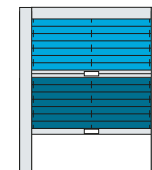

P2621 ^{1/2}
Double fabric, open at one side, with top fixed profile, side covering profiles and top covering profile.

Width	Extra charge
from 100 cm	52,00 €
from 100,1 to 120 cm	56,00 €
from 120,1 to 140 cm	60,00 €

Width	Extra charge
from 100 cm	74,00 €
from 100,1 to 120 cm	77,00 €
from 120,1 to 140 cm	83,00 €

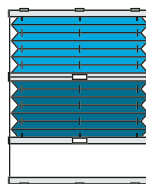

P2622 ^{1/2}
Double fabric, open at one side, with top fixed profile

42,00 €

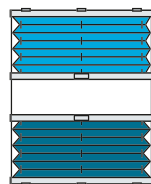

P2626 ^{1/2}
Double fabric, independent operation of top and bottom fabric, top and bottom profiles are fixed.

42,00 €



Models **P2620**, **P2621**, **P2622** and **P2626** are double fabric models. Please remember to add prices for both fabrics considering their price groups for the full size of the pleated blind.

DECOMATIC® PLAFOND

Important

You will find detailed information on components and pleated blind systems constructions in the product brochure. The brochure is also available in the digital version on our website.



Informations

- 1 Standard elements used for fixing are mounting clips. With a ready-made pleated blind you will receive a set of standard mounting parts necessary for mounting a certain pleated blind model.
- 2 Profiles can be powder coated in any RAL colour (individual pricing). Other components (end caps, mounting parts) are available in standard colours.
- 3 At customer's request we can modify a previously produced pleated blind. Such a pricing is prepared by our Customer Service. Modification in a pleated blind is made according to the applicable technology (e.g. decrease of blind, replacement of fabric or cords)



Colours of the PLAFOND profiles

RAL 9016

WHITE
POWDER COATED

RAL 9016

WHITE
STRUCTUR

RAL 9010

OFF WHITE
STRUCTUR



BRONZE
ANODISED

RAL 1015

BEIGE
POWDER COATED

RAL 9001

CREME
STRUCTUR

RAL 7040

GREY
STRUCTUR

E6/EV1

SILVER
ANODISED

RAL 7016

ANTHTACITE*
STRUCTUR

DB 703

DARK GREY
POWDER COATED

RAL 9005

BLACK
STRUCTUR

PLAFOND PROGRAM

* Components (mounting feet, handles, side caps) in black

PLAFOND PROGRAM

BASIC TABLE

Recommended retail prices including VAT

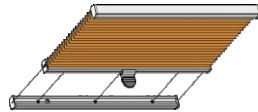

! Maximum production dimensions for each model are specified in the product brochure.
Check it out!

Mounting parts *: clips.
 Types of operation *: handle, cord, crank
 or electric motor operation

*depending on a pleated blind model.
 Detailed information in the product brochure and fabric catalogue.

		WIDTH											
PG		40	50	60	70	80	90	100	110	120	130	140	150
80	S	130	140	149	159	166	183	191	202	212	224	231	243
	0	144	157	165	177	185	204	212	224	237	248	257	270
	1	149	162	177	189	197	218	234	245	263	272	283	296
	2	158	175	189	201	215	239	255	270	283	298	314	329
	3	164	183	197	215	230	261	278	293	311	329	347	366
90	4	189	210	227	247	265	300	320	336	358	378	399	421
	S	133	143	153	164	173	189	199	210	222	231	243	254
	0	149	159	171	183	192	210	222	234	245	257	270	281
	1	152	167	179	192	206	228	243	255	270	281	296	311
	2	164	179	195	210	224	252	265	283	298	317	331	347
100	3	172	189	206	224	243	272	293	311	329	347	368	386
	4	198	217	237	258	279	313	336	358	378	399	423	444
	S	137	146	157	166	178	195	205	218	229	239	250	261
	0	152	162	175	185	197	215	228	243	255	265	278	290
	1	158	175	185	201	212	237	252	265	281	296	308	323
110	2	171	185	201	218	234	263	278	296	314	331	347	366
	3	178	197	215	234	252	288	308	326	347	368	389	407
	4	205	227	247	269	290	331	354	374	399	423	448	468
	S	140	151	162	173	183	199	212	224	237	248	258	272
	0	157	167	179	192	204	222	237	248	263	275	288	302
120	1	163	177	192	206	222	245	261	275	293	308	323	339
	2	176	192	206	224	243	272	293	311	329	347	366	383
	3	185	204	224	243	263	302	323	343	366	386	409	431
	4	213	235	258	279	302	347	372	395	421	444	471	495
	S	144	153	164	176	189	208	218	231	243	256	267	280
130	0	160	171	183	195	210	230	243	257	270	283	296	311
	1	167	183	197	212	228	255	270	288	302	321	335	353
	2	182	197	215	234	252	283	306	323	343	361	383	401
	3	192	212	234	252	272	314	339	361	383	407	431	452
	4	221	244	269	290	313	361	389	415	441	468	495	520
140	S	147	162	176	185	199	212	226	239	250	263	277	291
	0	164	179	195	206	222	237	252	265	278	293	308	323
	1	172	195	212	228	245	263	281	296	314	331	347	366
	2	188	215	234	255	275	296	317	339	359	376	399	419
	3	199	230	255	278	306	329	353	376	401	427	452	475
150	4	229	265	293	320	351	378	406	433	461	491	520	547
	S	151	164	178	191	205	218	231	245	258	272	285	298
	0	167	183	197	212	228	243	257	272	288	302	317	331
	1	177	201	218	237	255	272	290	308	326	343	361	379
	2	193	218	243	263	283	308	329	350	370	394	416	436
PG	3	208	239	265	290	317	341	368	394	419	445	472	497
	4	239	275	305	334	365	392	423	453	482	511	543	571
		40	50	60	70	80	90	100	110	120	130	140	150



The prices from the basic table refer to the models: **with handle P3400**.
 Extra charges for remaining models you will find on page 26-28.



Extra charges for models with electric motor on page 27.
 Extra charges for **electric motors and controls** on page 45-50.

PLAFOND PROGRAM

		WIDTH											
PG		40	50	60	70	80	90	100	110	120	130	140	150
150	S	153	171	183	197	210	226	239	254	267	280	294	307
	0	172	189	204	218	234	252	265	281	296	311	326	341
	1	182	206	224	243	263	281	298	317	339	356	374	392
	2	199	228	248	272	296	317	341	366	386	409	434	456
	3	213	248	275	302	329	356	383	409	442	464	490	520
4	246	285	316	347	378	410	441	471	509	533	563	598	
160	S	158	173	189	202	218	231	245	258	275	288	304	318
	0	176	192	210	224	243	257	272	288	306	321	339	353
	1	188	210	230	252	270	290	308	329	347	368	386	407
	2	205	234	257	281	306	329	353	376	401	425	448	472
	3	222	255	283	311	341	370	399	427	454	485	512	540
4	255	293	326	358	392	426	458	491	522	558	589	621	
170	S	162	178	191	208	224	237	254	267	282	296	311	326
	0	179	197	212	230	248	263	281	296	314	329	347	361
	1	192	215	237	257	278	296	317	339	359	379	401	421
	2	211	239	265	290	317	341	366	392	416	442	467	490
	3	228	263	293	323	353	383	412	442	472	502	532	563
4	262	302	336	372	406	441	473	509	543	578	612	647	
180	S	164	180	197	212	226	243	258	275	291	304	321	336
	0	183	201	218	237	252	270	288	306	323	339	356	374
	1	196	222	243	263	283	308	326	350	370	392	412	434
	2	217	248	272	298	326	353	376	403	431	456	485	512
	3	236	272	302	335	366	399	427	460	490	523	553	585
4	271	313	347	385	421	458	491	529	563	601	636	673	
190	S	167	185	202	218	234	250	267	280	298	311	330	344
	0	188	206	224	243	261	278	296	311	331	347	368	383
	1	201	228	248	272	293	314	339	359	383	403	427	448
	2	223	255	281	308	335	361	392	419	445	472	499	525
	3	242	281	311	347	376	412	442	475	507	540	573	606
4	278	323	358	399	433	473	509	547	583	621	659	697	
200	S	172	189	205	224	239	256	272	288	304	323	340	355
	0	191	210	228	248	265	283	302	321	339	359	376	394
	1	206	234	255	278	302	323	347	370	392	416	439	460
	2	229	261	290	317	347	374	403	431	460	490	517	547
	3	249	288	323	356	392	425	460	493	525	563	594	631
4	286	331	372	410	450	488	529	567	604	647	684	726	
210	S	176	195	210	226	245	261	280	296	311	330	347	367
	0	195	215	234	252	272	290	311	329	347	368	386	407
	1	211	239	263	288	311	331	356	383	403	427	452	475
	2	234	265	296	326	356	386	416	445	475	505	536	565
	3	257	296	331	368	403	439	475	512	547	580	616	651
4	296	340	381	423	464	505	547	589	629	667	708	749	
220	S	178	197	215	231	250	270	285	304	321	340	357	374
	0	198	218	239	257	278	298	317	339	356	376	399	416
	1	216	243	270	293	317	341	368	392	416	442	467	490
	2	241	275	306	339	368	399	427	460	490	520	553	583
	3	263	306	341	379	416	454	490	525	565	600	639	676
4	302	351	392	435	479	522	563	604	650	690	735	777	
230	S	182	202	222	237	256	275	294	311	330	347	367	385
	0	202	224	245	263	283	306	326	347	368	386	407	427
	1	221	248	275	302	326	353	376	403	427	454	478	505
	2	247	281	314	347	376	409	442	472	505	538	567	600
	3	271	314	353	392	431	467	505	545	583	622	661	696
4	312	361	406	450	495	537	581	627	670	715	760	800	
240	S	185	205	224	243	263	280	298	318	340	357	374	393
	0	206	228	248	270	293	311	331	353	376	399	416	436
	1	225	255	281	308	335	361	386	412	439	467	493	517
	2	252	290	323	356	389	421	454	487	520	553	585	618
	3	277	323	361	401	442	481	520	563	600	639	681	720
4	319	372	415	461	509	553	598	647	690	735	783	827	

PLAFOND PROGRAM

		WIDTH											
PG		40	50	60	70	80	90	100	110	120	130	140	150
250	S	189	210	229	248	267	288	307	326	344	367	385	403
	0	210	234	255	275	296	321	341	361	383	407	427	448
	1	230	261	288	317	341	370	399	425	452	478	505	532
	2	258	296	331	366	399	434	467	502	536	571	603	636
	3	285	331	370	412	454	497	538	577	618	661	702	744
4	328	381	426	473	522	571	619	663	711	760	807	856	
260	S	192	212	234	254	275	294	315	334	353	374	393	415
	0	213	237	261	281	306	326	350	370	392	416	436	460
	1	236	265	296	323	350	379	407	436	464	490	520	547
	2	264	302	339	374	409	445	481	514	550	585	622	653
	3	291	341	383	425	467	512	553	594	636	681	723	764
4	335	392	441	488	537	589	636	684	731	783	832	879	
270	S	196	218	239	258	280	298	321	342	360	382	403	422
	0	217	243	265	288	311	331	356	379	401	425	448	469
	1	239	272	302	331	359	389	416	445	475	502	532	563
	2	270	311	347	383	419	456	493	530	565	600	636	676
	3	298	347	392	436	481	523	567	612	653	699	744	789
4	343	399	450	502	553	601	652	704	751	804	856	907	
280	S	199	224	243	263	285	307	328	347	369	390	412	433
	0	222	248	270	293	317	341	366	386	409	434	456	481
	1	244	278	308	339	368	399	427	456	487	517	547	577
	2	276	317	356	392	431	467	505	545	580	618	653	694
	3	307	356	401	448	493	538	583	628	676	720	764	809
4	353	410	461	515	567	619	670	722	777	827	879	931	
290	S	202	226	248	270	291	311	334	355	376	399	420	441
	0	225	252	275	298	323	347	370	394	419	442	467	490
	1	249	283	314	343	376	407	436	467	497	530	558	589
	2	282	326	361	401	442	478	517	556	594	633	671	711
	3	313	366	412	456	505	553	600	645	694	741	786	833
4	359	421	473	525	581	636	690	742	798	852	903	958	
300	S	206	231	254	275	296	321	342	363	385	408	431	452
	0	229	257	281	306	329	356	379	403	427	454	478	502
	1	255	290	323	353	383	416	445	478	507	540	571	603
	2	288	331	370	412	452	490	532	571	610	651	691	729
	3	321	374	421	469	517	565	616	663	711	758	807	855
4	369	430	484	540	594	650	708	762	818	872	928	983	
310	S	210	234	258	280	304	326	347	372	393	418	439	464
	0	232	261	288	311	339	361	386	412	436	464	487	514
	1	259	296	329	359	392	425	456	490	520	553	585	618
	2	294	339	379	421	460	502	545	585	624	666	704	747
	3	327	383	431	481	532	580	631	681	729	780	827	878
4	376	441	495	553	612	667	726	783	838	897	951	1009	
320	S	213	239	263	285	309	330	355	379	401	425	449	471
	0	237	265	293	317	343	368	394	421	445	472	499	523
	1	263	302	335	368	401	434	467	499	532	565	598	631
	2	298	347	389	431	472	514	556	598	639	681	723	764
	3	335	392	442	493	545	594	645	696	747	797	848	899
4	385	450	509	567	627	684	742	800	859	917	975	1034	
330	S	216	243	267	291	315	340	363	388	408	433	456	482
	0	241	270	296	323	350	376	403	431	454	481	507	536
	1	269	308	341	374	409	442	475	512	545	577	612	645
	2	306	353	399	439	481	525	567	612	653	699	741	786
	3	341	401	452	505	556	610	661	714	764	817	869	924
4	392	461	520	581	639	701	760	821	879	940	1000	1062	
340	S	221	248	272	296	321	344	369	393	418	441	468	492
	0	244	275	302	329	356	383	409	436	464	490	520	547
	1	274	314	347	383	416	452	487	520	556	591	624	661
	2	311	361	403	448	493	538	580	624	669	714	758	804
	3	348	407	460	517	571	622	676	729	786	840	891	944
4	400	468	529	594	657	715	777	838	903	966	1024	1085	

PLAFOND PROGRAM

		WIDTH											
PG		40	50	60	70	80	90	100	110	120	130	140	150
350	S	224	250	277	302	326	350	376	401	425	452	475	500
	0	248	278	308	335	361	389	419	445	472	502	530	556
	1	278	317	353	389	425	460	497	532	567	603	639	676
	2	317	368	412	456	505	550	594	639	684	729	774	822
	3	356	416	472	525	583	636	694	747	804	858	913	968
360	4	410	479	543	604	670	731	798	859	925	986	1050	1114
	S	226	256	280	307	330	357	385	408	433	460	485	512
	0	252	283	311	341	368	399	427	454	481	512	538	567
	1	283	323	361	399	434	469	505	545	580	616	651	686
	2	323	374	421	467	514	563	606	653	699	747	791	840
370	3	362	425	481	538	594	651	709	764	822	878	935	988
	4	416	488	553	619	684	749	815	879	945	1009	1076	1137
	S	230	258	285	311	340	363	390	418	441	468	495	519
	0	256	288	317	347	376	403	434	464	490	520	550	577
	1	288	329	368	403	442	478	517	553	591	628	666	702
380	2	329	383	431	475	525	571	622	666	714	762	809	858
	3	370	434	490	550	606	666	723	780	840	895	955	1012
	4	426	499	563	632	697	766	832	897	966	1030	1099	1164
	S	234	263	291	318	344	372	399	425	449	475	502	530
	0	259	293	323	353	383	412	442	472	499	530	558	589
390	1	293	335	374	412	452	487	525	565	600	639	678	717
	2	335	389	436	487	536	583	633	681	729	780	827	875
	3	376	442	502	563	622	681	737	797	858	918	977	1037
	4	433	509	578	647	715	783	848	917	986	1055	1123	1192
	S	238	270	296	323	350	376	403	431	456	485	514	540
400	0	263	298	329	359	389	419	448	478	507	538	571	600
	1	297	341	379	419	456	497	536	577	612	651	691	729
	2	341	399	445	497	547	594	645	696	744	795	845	893
	3	385	452	512	571	633	694	756	815	875	938	997	1057
	4	442	520	589	657	728	798	870	937	1007	1078	1146	1215
400	S	244	272	298	328	355	385	412	439	466	495	521	548
	0	271	302	331	366	394	427	456	487	517	550	580	610
	1	307	347	386	427	467	505	547	585	624	666	704	744
	2	353	403	454	505	556	606	658	709	758	809	860	913
	3	399	460	520	583	645	709	771	833	893	955	1019	1082
400	4	458	529	598	670	742	815	887	958	1027	1099	1172	1244
	PG	40	50	60	70	80	90	100	110	120	130	140	150

Did you know that?

Pleated blinds for ceiling windows and winter gardens are available in various operation variants. Thanks to application of additional side guiding it is possible to install them in the horizontal position. Maximum roof tilt angle is 90°.

PLAFOND PROGRAM

EXTRA CHARGES



CORD OPERATION

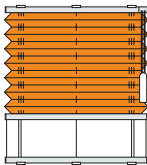

P3700
Open at one side
- upwards.
Only middle profile
is moveable.

104,00 €



HANDLE OPERATION

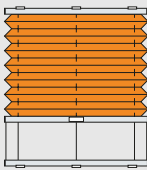

P3600
Open at one side
- upwards.
Only middle profile
is moveable.

NO EXTRA CHARGE

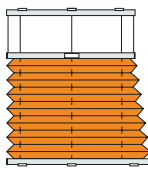

P3630
Special form:
trapezoid with
one-sided slant,
open at one side
- downwards.

74,00 €/m2
(min. 74 € max. 148 €)

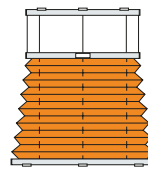

P3631
Special form:
trapezoid with
double-sided slant,
open at one side
- downwards.

74,00 €/m2
(min. 74 € max. 148 €)

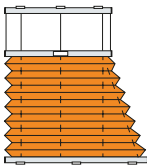

P3632
Special form:
trapezoid with
one-sided slant,
open at one side
- downwards.

65,00 €/m2
(min. 65 € max. 130 €)

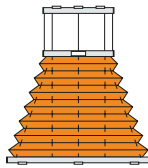

P3633
Special form:
trapezoid with
double-sided slant,
open at one side
- downwards.

65,00 €/m2
(min. 65 € max. 130 €)

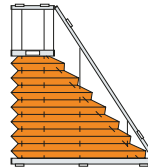

P3634
Special form:
trapezoid with
one-sided slant,
open at one side
- downwards.

130,00 €/m2
(min. 130 € max. 263 €)

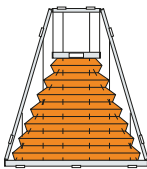

P3635
Special form:
trapezoid with
double-sided slant,
open at one side
- downwards.

130,00 €/m2
(min. 130 € max. 263 €)

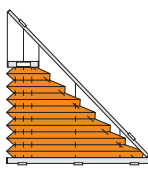

P3636
Special form:
triangle with
one-sided slant,
open at one side
- downwards.

130,00 €/m2
(min. 130 € max. 263 €)

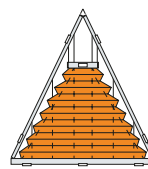

P3637
Special form:
triangle with
double-sided slant,
open at one side
- downwards.

130,00 €/m2
(min. 130 € max. 263 €)

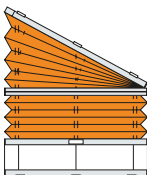

P3650
Special form:
open at one side
- upwards.
Only rectangular part
is moveable.

130,00 €/m2
(min. 78 € max. 263 €)

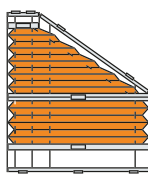

P3660
Special form:
open at both sides
- upwards and
downwards.

130,00 €/m2
(min. 78 € max. 263 €)

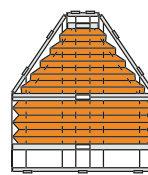

P3661
Special form:
open at both sides
- upwards and
downwards.

130,00 €/m2
(min. 78 € max. 263 €)

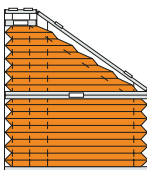

P3662
Special form:
open at one side
- downwards.

130,00 €/m2
(min. 78 € max. 263 €)

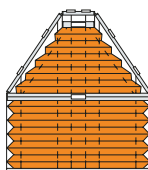

P3663
Special form:
open at one side
- downwards.

130,00 €/m2
(min. 78 € max. 263 €)

PLAFOND PROGRAM

EXTRA CHARGES



ELECTRIC MOTOR OPERATION

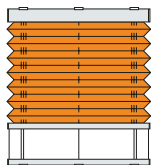

P3900
Open at one side - upwards.
Only middle profile is moveable.

74,00 €
+ 30,00 € /prm. of a blind's width

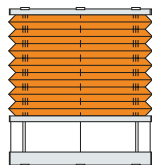

P3902
Open at one side - upwards.
Only middle profile is moveable.

74,00 €
+ 30,00 € /prm. of a blind's width

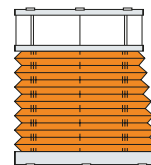

P3930
Special form: trapezoid with one-sided slant, open at one side - downwards.

74,00 €
+ 30,00 € /prm. of a blind's width
+ 65,00 € /m2 (min. 65 € max. 130 €)

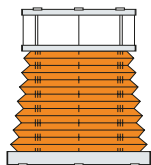

P3931
Special form: trapezoid with double-sided slant, open at one side - downwards.

74,00 €
+ 30,00 € /prm. of a blind's width
+ 65,00 € /m2 (min. 65 € max. 130 €)

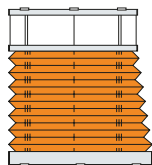

P3932
Special form: trapezoid with one-sided slant, open at one side - downwards.

74,00 €
+ 30,00 € /prm. of a blind's width
+ 65,00 € /m2 (min. 65 € max. 130 €)

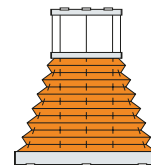

P3933
Special form: trapezoid with double-sided slant, open at one side - downwards.

74,00 €
+ 30,00 € /prm. of a blind's width
+ 65,00 € /m2 (min. 65 € max. 130 €)

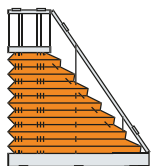

P3934
Special form: trapezoid with one-sided slant, open at one side - downwards.

74,00 €
+ 30,00 € /prm. of a blind's width
+ 65,00 € /m2 (min. 130 € max. 263 €)

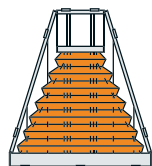

P3935
Special form: trapezoid with double-sided slant, open at one side - downwards.

74,00 €
+ 30,00 € /prm. of a blind's width
+ 65,00 € /m2 (min. 130 € max. 263 €)

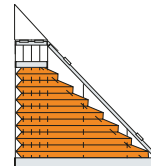

P3936
Special form: triangle with one-sided slant, open at one side - downwards.

74,00 €
+ 30,00 € /prm. of a blind's width
+ 65,00 € /m2 (min. 130 € max. 263 €)

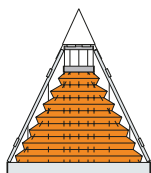

P3937
Special form: triangle with double-sided slant, open at one side - downwards.

74,00 €
+ 30,00 € /prm. of a blind's width
+ 65,00 € /m2 (min. 130 € max. 263 €)

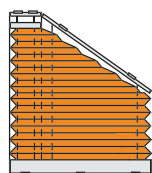

P3962
Special form with one-sided slant, open at one side - downwards.

74,00 €
+ 30,00 € /prm. of a blind's width
+ 65,00 € /m2 (min. 148 € max. 300 €)

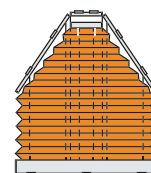

P3963
Special form with double-sided slant, open at one side - downwards.

74,00 €
+ 30,00 € /prm. of a blind's width
+ 65,00 € /m2 (min. 130 € max. 263 €)



IMPORTANT:

The price does not include electric components (motor, controls, power supply, etc.)
Extra charges for electric components you will find on pages 45-50

MOTORS:



somfy.
LW25 - B83 - 24V DC
195,00 €



somfy.
TILT&LIFT WireFree RTS - 12V
190,00 €



BREL BJE24D
165,00 €



matter
BJEM24D
0,8 Nm / 34 obr. / 12 V
175,00 €

PLAFOND PROGRAM

EXTRA CHARGES

CRANK OPERATION

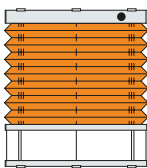

P3800
Open at one side - upwards.
Only middle profile is moveable.
74,00 €
+ 30,00 €/prm. of a blind's width

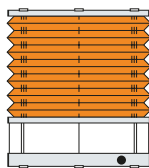

P3802
Open at one side - upwards.
Only middle profile is moveable.
74,00 €
+ 30,00 €/prm. of a blind's width

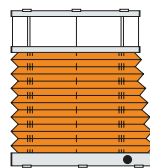

P3830
Special form: trapezoid with one-sided slant, open at one side - downwards.
74,00 €
+ 30,00 €/prm. of a blind's width
+ 65,00 €/m2 (min. 65 € max. 130 €)

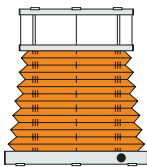

P3831
Special form: trapezoid with double-sided slant, open at one side - downwards.
74,00 €
+ 30,00 €/prm. of a blind's width
+ 65,00 €/m2 (min. 65 € max. 130 €)

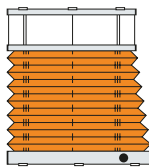

P3832
Special form: trapezoid with one-sided slant, open at one side - downwards.
74,00 €
+ 30,00 €/prm. of a blind's width
+ 65,00 €/m2 (min. 65 € max. 130 €)

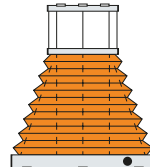

P3833
Special form: trapezoid with double-sided slant, open at one side - downwards.
74,00 €
+ 30,00 €/prm. of a blind's width
+ 65,00 €/m2 (min. 65 € max. 130 €)

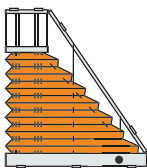

P3834
Special form: trapezoid with one-sided slant, open at one side - downwards.
74,00 €
+ 30,00 €/prm. of a blind's width
+ 65,00 €/m2 (min. 130 € max. 263 €)

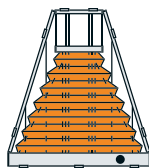

P3835
Special form: trapezoid with double-sided slant, open at one side - downwards.
74,00 €
+ 30,00 €/prm. of a blind's width
+ 65,00 €/m2 (min. 130 € max. 263 €)

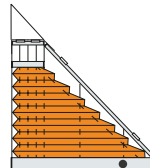

P3836
Special form: triangle with one-sided slant, open at one side - downwards.
74,00 €
+ 30,00 €/prm. of a blind's width
+ 65,00 €/m2 (min. 130 € max. 263 €)

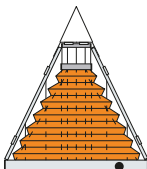

P3837
Special form: triangle with double-sided slant, open at one side - downwards.
74,00 €
+ 30,00 €/prm. of a blind's width
+ 65,00 €/m2 (min. 130 € max. 263 €)

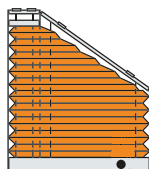

P3862
Special form with one-sided slant, open at one side - downwards.
74,00 €
+ 30,00 €/prm. of a blind's width
+ 65,00 €/m2 (min. 130 € max. 263 €)

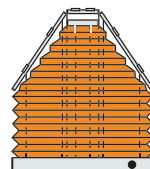

P3863
Special form with double-sided slant, open at one side - downwards.
74,00 €
+ 30,00 €/prm. of a blind's width
+ 65,00 €/m2 (min. 130 € max. 263 €)

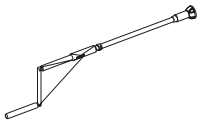
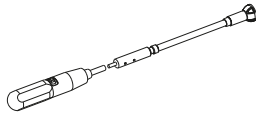

IMPORTANT: The price does not include cranks (look at the table below)

CRANK LENGTH [cm]	MANUAL CRANK	MOTORISED CRANK
100	111,00 € / pc.	253,00 € / pc.
150	114,00 € / pc.	257,00 € / pc.
200	118,00 € / pc.	262,00 € / pc.
		

WINTER GARDENS AND SKYLIGHTS

SMART PROGRAM

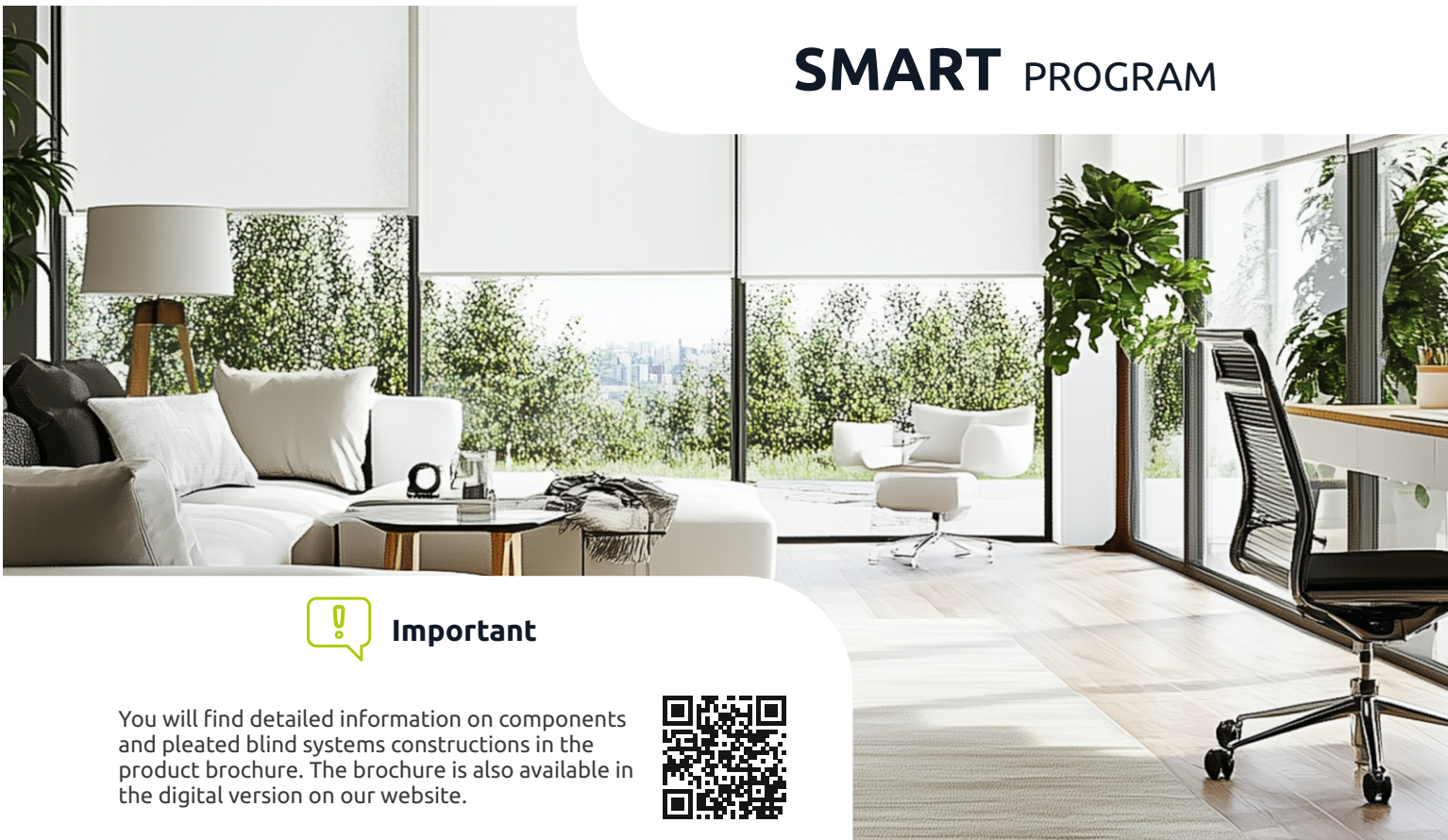

! Important

You will find detailed information on components and pleated blind systems constructions in the product brochure. The brochure is also available in the digital version on our website.



! Informationen

- Standard elements used for fixing are mounting feet or clips. With a ready-made pleated blind you will receive a set of standard mounting parts necessary for mounting a certain pleated blind model.
- For pleated blinds wider than 1,00m a PLUS profile 23 x 23mm (width x height) is used instead of the standard profile (17 mm height). It is possible to order pleated blinds with a width of less than 1.00 m with a reinforced profile for a surcharge according to the surcharge table on page 9 - simply tick the appropriate box on the order form.
- The models marked with symbols **PSM 420**, consist of two fabrics. To calculate the price of such a pleated blind summarise the basic pleated blind price with the first fabric and the basic pleated blind price with the second fabric, considering the fabric price group each time. This icon  will remind you to take into account the second fabric in the pricing.
- The fabric width in a pleated blind is equal to the width of the profiles, meaning it is exactly the same as the ordered dimension of the pleat. The maximum fabric widths for pleated blinds are provided on the catalog pages for each collection. In the case of pleats with ordered dimensions exceeding these values, the pleat may require vertical fabric joining (for an additional charge).
- Profiles can be powder coated in any RAL colour (individual pricing). Other components (end caps, mounting parts) are available in standard colours.
- At customer's request we can modify a previously produced pleated blind. Such a pricing is prepared by our Customer Service. Modification in a pleated blind is made according to the applicable technology (e.g. decrease of blind, replacement of fabric or cords).



Colours of the SMART profiles

Powder coated profiles:



Wood-like coating profiles*



* only for handle operated pleated blinds

** veneer not available for the model PSM 601

PROGRAM SMART

BASIC TABLE

Recommended retail prices including VAT

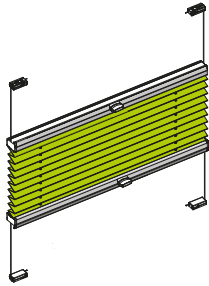

! Maximum production dimensions for each model are specified in the product brochure.
Check it out!

Mounting parts*: mounting foot, clips, brackets
Types of operation*: handle operation, cord operation

*depending on a pleated blind model.
Detailed information in the product brochure and fabric catalogue.

		WIDTH																	
PG		50	60	70	80	90	100	110	120	130	140	150	160	170	180	190	200	210	220
80	S	64	68	78	84	94	99	105	114	121	126	134	141	148	154	159	167	173	183
	0	71	75	85	93	104	109	117	128	134	142	149	156	165	171	178	186	193	203
	1	75	84	93	107	119	128	136	144	153	161	170	180	188	202	210	219	227	235
	2	84	93	107	119	131	144	153	167	175	188	197	210	219	232	240	254	262	275
	3	93	107	119	128	149	158	170	183	197	210	222	235	250	262	270	284	298	314
4	107	122	136	148	171	182	196	210	226	241	256	270	286	301	310	326	341	361	
90	S	66	71	82	88	97	104	109	119	126	133	142	148	156	161	168	177	182	193
	0	74	78	90	97	108	114	122	133	142	148	157	163	173	180	187	196	203	215
	1	80	88	97	112	125	134	143	153	162	171	181	191	199	213	221	232	241	250
	2	89	98	113	125	141	154	163	177	186	201	210	225	233	246	256	270	280	295
	3	98	113	126	137	159	169	182	197	210	226	239	254	268	281	291	305	319	338
4	114	129	145	157	182	194	210	227	242	259	275	292	307	323	335	352	367	388	
100	S	69	74	85	92	102	108	114	125	132	138	148	154	163	170	177	185	192	203
	0	76	83	94	101	113	119	128	141	148	154	163	171	182	190	197	206	213	226
	1	84	93	102	118	131	142	151	161	171	182	191	201	210	226	235	244	255	265
	2	94	105	119	133	148	162	173	188	198	213	222	238	250	263	274	289	299	315
	3	105	119	135	147	169	181	195	210	227	241	256	270	287	302	312	328	342	363
4	120	137	155	168	194	208	224	242	261	278	295	310	329	346	359	376	393	417	
110	S	72	78	88	96	107	114	119	131	137	146	154	161	171	178	185	193	202	211
	0	80	85	97	107	118	125	133	146	153	161	171	180	191	197	205	216	222	235
	1	87	97	108	123	137	148	159	169	180	191	202	211	221	238	247	258	268	280
	2	99	110	125	142	157	172	182	198	210	226	237	253	264	279	290	305	317	334
	3	110	126	143	156	179	192	207	225	240	256	273	289	304	322	334	350	366	386
4	127	145	165	179	205	221	238	258	276	295	314	332	350	369	383	403	420	443	
120	S	74	80	92	99	109	118	125	137	144	153	161	168	179	186	193	203	210	221
	0	83	89	102	109	122	131	138	151	159	168	179	187	198	206	215	226	233	246
	1	90	102	113	129	143	154	167	178	190	201	211	221	234	250	260	273	283	295
	2	104	117	132	148	165	181	193	209	221	238	250	267	279	295	307	323	336	353
	3	117	134	153	165	190	203	220	238	255	271	289	306	323	341	354	372	388	410
4	134	154	176	190	218	233	252	274	292	312	333	352	372	392	408	428	447	471	
130	S	78	84	96	102	114	122	131	142	150	158	167	176	186	193	203	211	220	232
	0	85	93	107	114	126	135	144	158	167	176	186	195	206	216	225	234	244	256
	1	95	108	119	135	149	161	173	186	197	210	221	233	245	261	274	286	298	310
	2	109	123	141	156	173	191	203	221	233	250	264	280	294	312	324	340	354	374
	3	123	142	159	173	198	215	232	251	269	288	305	323	342	362	375	393	411	435
4	142	163	184	199	227	247	267	289	310	331	352	372	393	416	431	453	473	499	
140	S	80	87	98	108	119	126	135	148	156	165	173	182	193	203	210	221	229	241
	0	89	97	109	119	131	142	150	163	173	182	193	203	215	225	233	244	255	268
	1	99	110	123	142	156	168	182	195	206	220	232	244	256	274	286	299	312	324
	2	114	129	147	163	182	198	211	231	244	263	278	295	310	327	340	358	373	393
	3	129	148	168	183	209	227	244	265	284	303	323	341	362	381	397	416	435	459
4	148	170	193	210	239	261	280	304	326	348	371	392	416	439	456	478	500	527	
PG		50	60	70	80	90	100	110	120	130	140	150	160	170	180	190	200	210	220



The prices from the basic table refer to the models: **with handle PSM 415, PSM 420**
Extra charges for remaining models you will find on page 33.

		WIDTH																	
PG		50	60	70	80	90	100	110	120	130	140	150	160	170	180	190	200	210	220
150	S	83	90	102	110	123	131	141	153	161	171	181	191	202	210	219	229	238	250
	0	92	100	114	123	136	146	156	170	180	190	201	210	222	233	244	255	264	278
	1	102	114	129	147	162	175	190	203	216	230	242	255	268	286	298	312	324	339
	2	119	135	153	171	191	208	221	241	256	275	290	310	324	342	357	376	391	413
	3	135	156	177	193	220	237	256	279	299	318	339	358	379	400	417	437	459	482
4	155	179	204	221	252	272	295	321	344	365	389	412	436	459	480	504	527	554	
160	S	85	94	107	114	126	136	146	159	167	177	187	197	209	219	227	238	246	260
	0	95	102	118	128	142	151	161	176	186	197	208	219	232	242	253	264	274	289
	1	108	119	133	153	168	182	197	210	225	239	253	266	280	298	312	325	339	353
	2	125	142	159	179	197	217	232	253	268	288	304	323	340	358	374	393	410	434
	3	142	162	185	203	229	247	268	292	313	334	356	376	398	420	437	460	481	506
4	162	187	213	233	263	284	309	335	360	384	408	433	458	482	504	530	553	582	
170	S	88	97	108	119	131	142	150	163	173	183	193	204	216	227	235	246	256	269
	0	97	108	121	131	146	156	167	182	193	203	216	227	240	250	262	274	285	300
	1	110	125	137	158	175	188	204	220	233	250	262	276	291	310	323	339	352	368
	2	130	147	167	186	206	227	242	263	280	300	317	337	354	374	391	411	428	453
	3	147	170	193	211	239	259	280	306	328	349	373	393	417	440	459	482	505	530
4	168	196	221	244	275	298	323	352	376	402	429	453	480	505	527	555	580	609	
180	S	90	99	113	123	135	146	155	169	180	191	201	210	225	233	244	255	266	280
	0	100	110	125	136	150	161	172	188	199	210	222	234	250	260	271	284	295	310
	1	114	130	143	163	181	195	211	228	242	258	273	287	304	322	336	352	367	383
	2	135	153	173	193	215	235	251	274	292	313	331	352	370	390	408	428	447	473
	3	153	177	202	221	250	270	293	319	342	363	388	411	436	459	480	505	527	554
4	176	204	233	254	286	310	337	367	393	419	447	473	501	528	552	580	607	637	
190	S	93	102	117	126	138	149	161	175	185	196	207	219	232	242	253	264	274	289
	0	102	114	129	142	154	167	178	193	206	217	231	242	256	268	280	293	305	322
	1	119	133	148	170	187	203	220	237	250	268	283	298	315	334	349	366	381	397
	2	141	159	181	202	222	244	261	285	304	325	344	365	386	406	425	447	465	493
	3	159	185	210	231	259	281	305	334	357	380	406	428	454	480	500	527	549	578
4	182	212	241	265	298	323	352	383	409	437	467	493	522	552	576	607	631	665	
200	S	96	107	119	131	143	154	166	181	191	203	215	226	239	250	261	274	284	299
	0	107	118	132	144	159	171	183	201	213	225	238	250	266	278	290	304	315	332
	1	123	137	154	176	193	209	227	244	260	278	293	308	327	346	362	379	395	412
	2	144	165	187	209	231	254	271	295	316	338	357	379	399	422	442	464	483	512
	3	165	192	219	240	268	293	318	347	371	396	422	447	473	499	522	548	573	601
4	190	221	250	276	309	337	365	399	426	454	485	513	544	573	601	630	658	692	
210	S	98	108	123	134	148	159	170	185	197	208	221	232	246	258	269	281	293	308
	0	108	121	136	149	163	177	190	206	219	232	244	258	274	287	299	313	325	342
	1	126	143	159	182	199	216	234	253	268	288	304	318	338	358	374	392	408	427
	2	150	171	193	216	239	262	280	306	328	350	371	393	414	437	459	482	503	533
	3	171	198	227	250	279	304	329	361	386	411	439	465	493	519	543	571	595	625
4	197	227	261	287	321	350	380	414	443	471	505	533	566	597	624	655	685	720	
220	S	101	113	126	137	153	163	175	191	203	215	228	239	255	266	278	290	303	318
	0	112	124	142	153	168	182	195	211	226	238	253	266	283	295	308	323	336	353
	1	131	148	163	187	206	221	241	261	278	298	313	329	349	370	387	406	423	442
	2	155	177	201	225	247	271	290	317	339	363	384	408	430	453	476	499	521	553
	3	177	206	234	259	289	316	342	374	400	426	455	482	510	539	564	593	618	650
4	204	237	269	298	333	363	393	430	459	490	524	554	587	620	649	682	711	748	
230	S	104	114	131	142	156	168	181	197	209	221	234	245	262	274	287	299	312	328
	0	114	128	144	158	173	186	201	219	232	245	260	274	290	304	318	332	346	363
	1	134	153	169	193	211	229	250	269	287	306	323	340	361	382	399	420	437	457
	2	159	183	207	232	256	280	301	328	352	374	398	422	445	470	493	517	539	572
	3	183	213	244	268	299	328	354	387	414	442	471	499	529	559	584	615	642	674
4	210	244	279	309	344	376	408	446	476	508	542	573	608	643	672	708	738	774	
240	S	107	119	133	147	159	173	185	203	215	227	241	254	269	281	295	308	322	338
	0	119	131	148	162	178	192	206	225	238	253	268	280	299	313	328	342	357	374
	1	138	156	173	199	219	237	256	278	295	316	334	352	373	395	412	434	450	471
	2	166	190	215	239	265	289	310	339	363	387	411	436	459	485	509	534	558	592
	3	190	221	251	278	310	339	367	401	430	459	488	517	548	578	606	637	665	697
4	218	253	289	320	356	389	422	461	494	527	561	595	629	666	697	732	765	802	
PG		50	60	70	80	90	100	110	120	130	140	150	160	170	180	190	200	210	220

		WIDTH																	
PG		50	60	70	80	90	100	110	120	130	140	150	160	170	180	190	200	210	220
250	S	108	121	137	150	165	178	191	207	221	233	247	260	278	290	304	317	329	347
	0	121	135	153	167	182	197	211	231	244	259	274	289	307	323	337	352	366	386
	1	143	161	179	205	225	244	264	286	304	325	344	363	384	407	425	447	465	486
	2	170	195	221	246	273	299	322	349	374	400	425	450	475	500	527	552	577	612
	3	195	228	260	288	318	350	379	414	444	473	505	534	567	599	627	660	688	722
4	224	262	298	331	366	403	436	476	510	544	581	614	652	689	721	759	791	830	
260	S	112	125	142	154	168	182	196	213	227	240	255	268	285	298	312	325	339	357
	0	124	137	156	171	187	203	217	237	251	267	281	298	316	331	346	362	376	397
	1	147	166	185	210	231	250	271	294	313	335	353	373	396	418	437	459	479	500
	2	176	202	228	255	280	307	329	361	386	412	437	465	490	517	543	569	595	631
	3	202	234	268	298	329	362	391	428	459	488	522	552	585	618	649	680	711	745
4	233	269	307	341	378	416	450	493	527	561	601	635	673	711	745	782	818	857	
270	S	114	128	143	158	173	186	201	219	233	245	261	274	292	306	319	335	348	366
	0	126	142	159	175	192	207	221	242	258	274	289	304	324	340	356	372	387	407
	1	150	170	190	216	238	256	279	303	322	346	363	384	407	431	450	473	493	516
	2	181	207	234	262	289	317	340	371	397	425	451	479	505	533	559	587	613	652
	3	207	242	276	306	339	373	403	442	473	505	539	569	603	639	669	703	734	769
4	238	278	318	352	389	429	465	508	544	580	619	655	694	734	768	808	845	884	
280	S	118	131	148	161	177	191	205	225	238	253	268	281	300	314	328	343	357	375
	0	130	146	163	180	197	211	228	250	265	280	298	313	334	349	365	381	397	417
	1	154	175	195	221	244	263	287	312	331	354	374	395	418	442	462	486	506	530
	2	185	215	241	269	298	325	350	381	410	437	465	493	520	548	577	605	631	672
	3	215	250	285	316	349	384	416	455	487	519	555	587	623	658	690	726	757	794
4	246	286	328	363	402	442	478	524	560	597	638	675	716	756	793	833	870	913	
PG		50	60	70	80	90	100	110	120	130	140	150	160	170	180	190	200	210	220

Did you know that?



In the production of pleated blind we rely on the leading in Europe system DECOMATIC® of German company BENTHIN. This system guarantees the highest quality of details and modern solutions, translating into reliable use for many years.

Price estimation step by step



For the purposes of the calculation, we used following parameters:

Dimensions - 87,5 cm x 109,3 cm
Model - PSM100
Fabric - 1-1350 PL (PG: 1)

1

Take a measurement, 87,5 cm x 109,3 cm (width x height)

2

Find the price in the price table, according to both: measurements rounded up and price group (PG) of a chosen fabric, e.g. 90 cm x 110 cm (137 €)

3

Choose the model of pleated blind (page 14-20) P1705 (extra charge for the model 25,00 €)

4

Recommended retail price including VAT (137 € + 25 € = 162 €)



How to consider the extra charges which depends to the width or height of the pleated blind? **It's easy!**
E.g. **PSM105** with ordering width 849 mm:
(0,90m x 40 €) = 36,00 €

PROGRAM SMART

TILT & TURN WINDOWS



HANDLE OPERATION

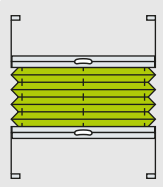

PSM415
Open at both sides - upwards and downwards.

NO EXTRA CHARGES

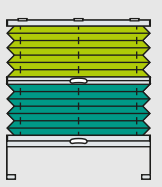

PSM420
Double fabric, open at one sides - upwards.

NO EXTRA CHARGES

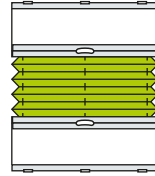

PSM412
Open at both sides - upwards and downwards, with top and bottom fixed profile.

25,00 € /prm.
of a blind's width

Available profile colors:



WHITE POWDER COATED



WHITE MATT



SILVER



GREY MATT



ANTHRAZIT MATT



BLACK MATT



GOLDEN OAK



WINCHESTER*



WALNUT



PINE



CORD OPERATION

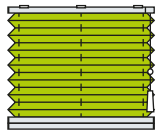

PSM100
Open at one side - upwards.

25,00 €

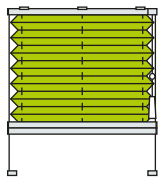

PSM105
Open at one side - upwards, with top fixed profile and side guiding.

40,00 €

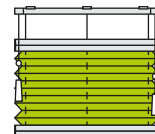

PSM110
Open at both sides - upwards and downwards, with top fixed profile.

50,00 €
25,00 € /prm.
of a blind's width

Available profile colors:



WHITE POWDER COATED



WHITE MATT



SILVER



GREY MATT



ANTHRAZIT MATT



BLACK MATT

ROOF WINDOWS



HANDLE OPERATION

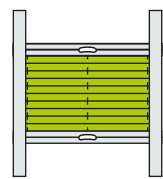

PSM616
Open at both sides - upwards, and downwards, with side covering profiles.

Height Extra charge

from 100 cm	40,00 €
from 100,1 to 120 cm	51,00 €
von 120,1 bis 140 cm	57,00 €

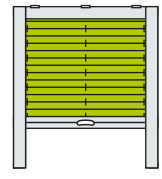

PSM601
Double fabric, open at one side, with top fixed profile, side covering profiles and top covering profile.

Height Extra charge

from 100 cm	40,00 €
from 100,1 to 120 cm	51,00 €
from 120,1 to 140 cm	57,00 €

Available profile colors:



WHITE POWDER COATED



WHITE MATT



SILVER



GREY MATT



ANTHRAZIT MATT



BLACK MATT



GOLDEN OAK



WINCHESTER*



WALNUT



PINE

PLISSEES SMART

PLEATED 16 mm



Important

Detailed information about profile dimensions, components, and the pleated blind construction can be found in the 16mm pleated blind fabric collection and in the product brochure. The product brochure is available in electronic form on our website.



Informations

- 1 By default, 16mm pleated blinds are attached with mounting brackets. With the finished pleated blind, you will receive a set of standard brackets that are necessary for mounting the pleated blind. The other available mounting option for 16mm pleated blinds is non-invasive, self-adhesive mounting strips - Model P4616.
- 2 The 16mm pleated blinds are available in three colors: RAL 9016 white lacquered, silver anodized E6/EV1, and RAL 7016 anthracite gray sand structure, available only for the P4615 model. All plastic parts (mounting brackets, operating handles, side caps) are colormatched to the profile. An exception is the anthracite gray textured color, where the components are in black.
- 3 The fabric width in a pleated blind is 3 mm narrower than the ordered size due to the thickness of the side caps that close the pleated profiles.



Pleated 16 mm Profil-Color

RAL
9016

WHITE
POWDER COATED

E6/EV1

SILVER
ANODISED

RAL
7016

ANTHRACITE
STRUCTURE*

PLEATED 16 mm

PLEATED 16 mm

BASIC TABLE

Recommended retail prices including VAT

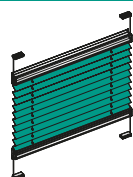

! You can find the maximum and minimum dimensions in the product brochure / 16mm pleated blind collection.

Mounting parts*: mounting feet, clips brackets, clamp brackets
Types of operation*: handle profile

		WIDTH										
PG		40	50	60	70	80	90	100	110	120	130	140
70	S	87	95	104	114	123	132	142	150	159	169	178
	0	89	99	108	117	127	137	146	156	166	176	185
	1	94	106	116	127	139	150	161	172	183	195	206
	2	102	115	128	140	154	167	180	193	206	219	233
80	3	114	131	146	162	178	194	211	226	242	258	274
	S	89	99	109	119	128	137	147	157	167	177	187
	0	91	102	112	122	133	143	154	163	173	184	194
	1	98	110	123	134	146	158	170	182	194	206	218
90	2	106	121	135	149	163	178	192	206	221	235	248
	3	121	138	156	173	191	208	226	244	261	280	296
	S	91	102	112	123	133	144	154	163	174	184	195
	0	94	105	116	127	138	149	160	171	182	193	204
100	1	102	115	128	140	154	167	180	192	205	218	232
	2	112	127	143	158	172	189	204	219	235	250	266
	3	127	146	166	184	204	224	242	261	281	301	319
	S	94	105	116	127	138	149	160	171	182	193	204
110	0	97	109	121	132	144	156	167	179	191	202	214
	1	105	120	133	147	161	174	189	203	216	230	245
	2	116	133	149	166	182	199	215	232	249	266	282
	3	134	155	176	196	217	238	259	280	301	321	342
120	S	97	109	120	132	143	155	166	178	189	201	213
	0	100	112	124	137	149	161	174	187	199	212	224
	1	110	124	138	154	169	183	198	213	227	242	257
	2	121	139	156	174	192	210	227	245	262	281	298
130	3	140	162	184	207	230	252	274	297	319	342	364
	S	99	111	123	136	148	160	172	184	196	208	222
	0	103	115	128	142	155	168	181	194	207	221	234
	1	113	128	144	160	176	191	207	223	238	253	270
140	2	126	145	163	182	201	221	239	258	277	296	315
	3	147	170	194	218	242	267	291	315	339	363	387
	S	101	114	127	140	153	166	179	191	204	217	229
	0	105	120	133	147	160	174	188	202	216	229	244
150	1	116	133	150	167	183	200	216	233	249	266	282
	2	131	150	171	191	211	230	251	271	291	311	331
	3	153	179	204	230	256	281	307	332	358	384	409
	PG	40	50	60	70	80	90	100	110	120	130	140

*Depending on a pleated blind model.
Detailed information in the product brochure and fabric catalogue.



The prices in the basic table refer to the models with handle P4615.
Additional charges for the remaining models can be found on page 36.

PLEATED 16 mm

		WIDTH										
PG		40	50	60	70	80	90	100	110	120	130	140
140	S	104	117	131	145	158	171	184	199	212	225	238
	0	108	123	137	151	166	181	195	210	224	238	253
	1	120	137	155	173	190	207	225	242	260	278	295
	2	135	157	178	199	221	241	262	284	305	326	348
	3	159	187	214	241	268	295	323	350	377	405	432
150	S	106	121	135	149	162	177	191	205	219	234	247
	0	111	126	142	157	171	188	202	217	233	248	263
	1	124	143	160	179	198	216	235	253	271	290	308
	2	139	162	184	207	229	252	274	297	319	342	364
	3	166	195	224	252	281	311	339	369	397	426	454
160	S	109	124	138	153	168	182	198	212	226	241	256
	0	114	129	145	161	178	193	210	225	240	257	273
	1	127	147	166	185	205	224	244	262	282	302	321
	2	145	168	192	215	239	263	286	309	334	358	381
	3	172	203	233	263	294	325	356	385	416	447	477
170	S	112	127	142	157	172	188	203	218	234	249	264
	0	116	133	149	166	183	200	216	233	249	266	283
	1	132	151	171	192	212	233	252	273	293	314	334
	2	149	174	199	224	248	273	298	323	348	373	397
	3	179	211	242	274	307	339	371	404	436	467	500
180	S	114	129	146	161	178	193	210	226	241	258	
	0	120	136	154	171	189	205	223	240	258	275	
	1	135	156	178	199	219	240	262	283	304	326	
	2	154	180	206	232	258	284	309	336	362	388	
	3	184	218	252	286	320	353	387	421	454	488	
190	S	116	133	149	166	182	200	216	233	249	266	
	0	122	140	158	176	194	212	230	248	267	284	
	1	138	160	182	204	226	249	271	293	315	337	
	2	159	187	213	240	268	295	321	349	376	404	
	3	191	227	262	297	332	369	404	439	474	509	
200	S	119	136	154	170	188	205	222	239	257		
	0	125	144	162	181	200	218	237	256	274		
	1	142	165	188	211	234	257	280	303	326		
	2	163	192	221	248	277	305	334	362	391		
	3	198	235	272	308	346	383	419	456	494		
210	S	122	139	157	174	193	211	228	246	263		
	0	127	147	167	185	205	225	244	263	283		
	1	146	170	193	217	241	266	290	313	337		
	2	168	198	227	257	286	316	346	375	404		
	3	204	244	281	320	359	397	436	474	512		
220	S	124	143	160	179	198	216	235	252			
	0	131	150	170	191	211	232	251	271			
	1	149	174	199	224	249	273	298	323			
	2	173	204	234	266	295	327	358	387			
	3	211	251	291	331	371	411	452	492			
230	S	126	146	165	183	203	222	240	260			
	0	133	155	174	195	216	237	258	279			
	1	153	179	204	230	256	282	307	334			
	2	178	210	241	273	305	337	369	400			
	3	217	259	301	342	384	426	467	509			
PG		40	50	60	70	80	90	100	110	120	130	140

ADDITIONAL COST FOR MODEL P4616

SELF-ADHESIVE MOUNTING STRIPS

		WIDTH										
P4616		40	50	60	70	80	90	100	110	120	130	140
		36	43	48	55	61	67	74	80	87	92	99

PROGRAM SKYLIGHT



Wichtig

You will find detailed information on components and pleated blind systems constructions in the product brochure. The brochure is also available in the digital version on our website.



Colours of the SKYLIGHT profiles

E6/EV1

SILVER
ANODISED



Informations

- 1 With a ready-made pleated blind you will receive a set of standard mounting parts necessary for mounting a given pleated blind model.
- 2 The price table for roof roller blinds consists of size modules. Each module reflects a specific size (width - height) of the roof window. The dimensions of the modules match the dimensions of most roof windows offered by major European manufacturers.
- 3 When placing an order for a roof pleated blind, please provide dimensions - width and height of the inner side of a window frame. To exclude any mistakes, it is also important to provide the symbol, type as well as the production year of a roof window in order form notes. This information can be found on the rating plate located on the window frame.
- 4 At customer's request we can modify a previously produced pleated blind. Such a pricing is prepared by our Customer Service. Modification in a pleated blind is made according to the applicable technology (e.g. decrease of blind, replacement of fabric or cords).

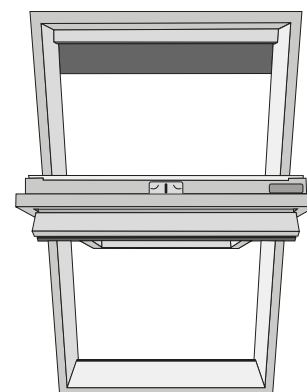

RATING
PLATE

SKYLIGHT PROGRAMM

SKYLIGHT PROGRAM

BASIC TABLE

Recommended retail prices including VAT

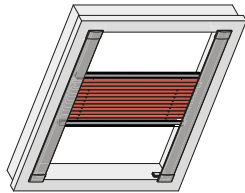

Mounting: side guiding
Type of operation: operated by bottom rail

		WIDTH MODULES						
		PG	38	50	62	78	98	118
HEIGHT MODULES	55	S	124	149	163	172	201	210
		0	130	159	175	185	223	232
		1	134	168	189	201	246	255
		2	144	182	209	226	280	290
		3	159	207	243	264	340	350
	74	4	182	238	279	303	391	402
		S	140	155	169	179	209	218
		0	145	165	182	192	232	241
		1	152	175	197	209	256	265
		2	165	189	217	235	292	301
	94	3	184	215	252	274	354	364
		4	211	247	290	315	407	418
		S	162	168	177	188	204	240
		0	172	179	192	205	226	272
		1	184	193	209	224	249	307
	116	2	202	215	233	254	287	359
		3	232	252	277	302	345	447
		4	267	290	319	348	397	514
		S	185	191	197	202	221	248
		0	203	209	215	223	247	280
136	1	222	229	236	246	276	316	
	2	252	259	267	280	319	370	
	3	302	312	321	340	393	461	
	4	348	359	369	391	452	530	
	S	198	204	210	216	235	255	
		PG	38	50	62	78	98	118
		WIDTH MODULES						

Did you know that?

Simple mounting, performed precisely according to instruction does not affect any window components whose damage might result in losing warranty rights for the window.

BASIC & COMFORT EXTRA CHARGES

BRACKETS

code 1064



PVC bracket for mounting feet
white, beige, brown, grey, black

3,90 € /Set (L+R)
Set - 2 pcs.

code 1063



PVC bracket with clip 20 mm
white, beige, brown, grey, black

3,80 € /pc.

code 1060



PVC bracket with clip 27 mm
white, beige, brown, grey, black

3,80 € /pc.

code 1057



Small metal bracket for mounting feet
white, beige, brown, grey, black

4,45 € /Set (L+R)
Set - 2 pcs.

code 1056



Small metal bracket with clip 20 mm
white, beige, brown, grey, black

3,90 € /pc.

code 1065



Small metal bracket with clip 27 mm
white, beige, brown, grey, black

4,15 € /pc.

code 1053



Standard metal bracket for mounting feet
white, beige, brown, grey, black

4,85 € /Set (L+R)
Set - 2 pcs.

code 1052



Standard metal bracket with clip 20 mm
white, beige, brown, grey, black

4,05 € /pc.

code 1048



Standard metal bracket with clip 27 mm
white, beige, brown, grey, black

4,20 € /pc.



IMPORTANT: The ratio of the number of mounting parts to the width of the pleated blind can be found in the table on page 33

code 1234

Additional elements were marked with indexes, which can be used when placing orders. Instead of providing the full name of the element, you can use the assigned index number.

Standard mounting parts for proper model of the pleated blind. More information can be found in our Product Brochure.



BASIC & COMFORT EXTRA CHARGES

BRACKETS

code 1038



**Metal bracket with PVC cover
for mounting feet**
white, beige, brown, grey, black

5,80 € /Set (L+R)
Set - 2 pcs.

code 1037



**Metal bracket with PVC cover
with clip 20 mm**
white, beige, brown, grey, black

4,75 € /pc.

code 1033



**Metal bracket with PVC cover
with clip 27 mm**
white, beige, brown, grey, black

4,90 € /pc.

MOUNTING CLIPS

code 1023



Standard Clip 20 mm
white, beige, brown, grey, black

1,80 € /pc.

code 1019



Standard Clip 27 mm
white, beige, brown, grey, black

2,05 € /pc.

ADJUSTABLE BRACKET

code 1045



**Adjustable bracket
60 - 108 mm with Clip 20 mm**
white, silver

- 8,25 € /pc.**
- 9,05 € /pc.**

code 1044



**Adjustable bracket
60 - 108 mm with Clip 27 mm**
white, silver

- 8,40 € /pc.**
- 9,30 € /pc.**



IMPORTANT:

The ratio of the number of mounting parts to the width of the pleated blind can be found in the table on page 33.

code 1234

Additional elements were marked with indexes, which can be used when placing orders. Instead of providing the full name of the element, you can use the assigned index number.



Standard mounting parts for proper model of the pleated blind.
More information can be found in our Product Brochure.

BASIC & COMFORT EXTRA CHARGES

MOUNTING FEET

code 1024 



Standard mounting feet
white, beige, brown,
grey, black

2,40 € /pc.

code 1123



**Mounting feet
for windows with narrow
glazing beads**
white, beige, brown,
grey, black

2,40 € /Set (L+R)
Set - 2 pcs.

code 1124



**Mounting feet for
windows with rounded
glazing beads**
white, beige, brown,
grey, black

1,70 € /Set (L+R)
Set - 2 pcs.

code 1132



**Non-invasive (self-adhesive)
mounting feet**
in white

Maximum pleated blind area - 2m2

15,45 € /Set
Set - 4 pcs.

OPERATING ELEMENTS

code 1077
code 1090
code 1083



Operation rod
anodized in silver

100 cm - **42,00 € /pc.**
150 cm - **47,00 € /pc.**
200 cm - **52,00 € /pc.**

code 1080
code 1081
code 1082

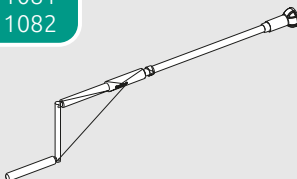

Manual crank
anodized in silver

100 cm - **111,00 € /pc.**
150 cm - **114,00 € /pc.**
200 cm - **118,00 € /pc.**

code 1085
code 1086
code 1088

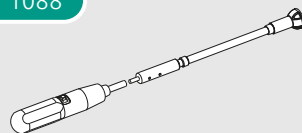

Motorised crank
anodized in silver

100 cm - **253,00 € /pc.**
150 cm - **257,00 € /pc.**
200 cm - **262,00 € /pc.**

This table defines the number of clips you obtain for mounting one fixed profile of chosen pleated blind (in case when the model has two fixed profiles, the number of clips is multiplied x2). Please use the data from the table for determining the needed amount of mounting clips, non-invasive brackets or adjustable brackets. These elements you will find on pages 31-35.

WIDTH OF THE PLEATED BLIND (mm)	NUMBER OF CLIPS
0 - 400	2 pcs.
401 - 900	3 pcs.
901 - 1400	4 pcs.
1401 - 1900	5 pcs.
1901 - 2400	6 pcs.
2401 - 2900	7 pcs.
2901 - 3400	8 pcs.

code 1234 

Additional elements were marked with indexes, which can be used when placing orders. Instead of providing the full name of the element, you can use the assigned index number.

Standard mounting parts for proper model of the pleated blind. More information can be found in our Product Brochure.

BASIC & COMFORT EXTRA CHARGES

NON-INVASIVE BRACKETS

code 1016



Window frame clamp
for models P1414 and P1614

2,95 € /pc.

code 1043



Block holder for mounting feet
white, beige, brown, grey, black

7,45 € /pc.

code 1122



Block holder
white, beige, brown, grey, black

5,60 € /pc.

code 1042



Block holder with mounting clip 20 mm
white, beige, brown, grey, black

7,80 € /pc.

code 1030



Block holder with mounting clip 27 mm
white, beige, brown, grey, black

8,00 € /pc.

code 2150



Block holder for side guiding
white, beige, brown, grey, black

7,45 € /pc.

MOUNTING SLATS

code 1026



Adhesive profiles with adjustable brackets (Model P1416, P1616)
white, silver, anodised

do 100 cm - **48,00 €** /Set
100,1 - 150 cm - **64,00 €** /Set
150,1 - 200 cm - **81,00 €** /Set
200,1 - 220 cm - **89,00 €** /Set

Set - 2 pcs.

code 1128



Slats glued to the window frame with PVC brackets
white, silver, anodised

do 100 cm - **32,00 €** /Set
100,1 - 150 cm - **41,00 €** /Set
150,1 - 200 cm - **49,00 €** /Set
200,1 - 220 cm - **53,00 €** /Set

Set - 2 pcs.

code 1076

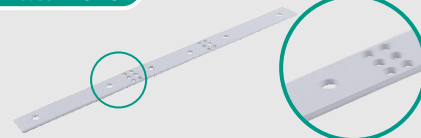

Mounting strip flexible
white, silver, black

100 cm - **10,70 €** /pc.



Standard mounting parts for proper model of the pleated blind.
More information can be found in our Product Brochure.



IMPORTANT: The ratio of the number of mounting parts to the width of the pleated blind can be found in the table on page 33

BASIC & COMFORT EXTRA CHARGES

OTHER COMPONENTS

code 1125

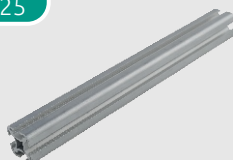

Mounting profile (aluminium)
25x25 mm (max. length 300 cm)
powder coated - white, beige
anodised - silver, black, brown

48,30 € /pc.

code 1126



Bearing mounting profile
white, beige, brown, grey, black

4,65 € /pc.

code 1127



Sliding block with clip
powder coated - white, beige
anodised - silver, black, brown

2,60 € /pc..

code 1130



Standard handle operation
(no extra charge in Basic program)
white, beige, brown, grey, black

1,50 € /pc.

code 1129



Swivel handle operation
transparent

2,65 € /pc.

code 1084



„MODERN“ handle operation
(no extra charge in Comfort program)
white, beige, brown, grey, black

2,95 € /pc.

code 1078



„METALL“ handle operation
white, beige, brown, grey, black

8,00 € /pc.

code 1131



Distance plate
for window frame clamp
white, beige, brown, grey, black,
anhtracite

1,25 € /pc.

code 1074



Mounting wedge 15°
transparent

0,65 € /pc.

code 1234

Additional elements were marked with indexes, which can be used when placing orders. Instead of providing the full name of the element, you can use the assigned index number.

SMART EXTRA CHARGES

OTHER COMPONENTS



Bedienungsgriffe

1,30 € /pc.



Spannschuh

1,30 € /pc.

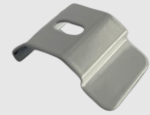

25 mm Clip
white, creme, bronze, grey, black

0,80 € /pc.



The products presented in the **ELECTRIC MOTORS AND CONTROLS** section come from external suppliers - **SOMFY, COULISSE, VESTAMATIC**. Current prices and availability of products are determined according to their offer on the day the order is received.

MOTORS AND CONTROLS



MOTORS



TILT&LIFT WireFree RTS
0,8 Nm | 30 rpm. | 12 V

(1002461)
190,00 €



Somfy TILT&LIFR 25 WF Zigbee
0,8 Nm | 30 rpm. | 12V

(1245601)
205,00 €



Somfy LW25 - B83
0,8 Nm | 30 rpm. | 24 V

(1000031)
195,00 €



Somfy TLW25 WT
24V DC

(1241392) 0,8 Nm | 32 rpm. | 24 V DC
215,00 €
(1241393) 1,2 Nm | 32 rpm. | 24 V DC
320,00 €



POWER SUPPLY 12 V



Power Supply
for WireFree motors
12 V

(1822445)
52,00 €



Batterypack
for Tilt&Lift RTS motor

(9021217)
110,00 €



Solar Panel
for Batterypack

(9025293)
86,00 €



Power Supply
for LI-ION batteries in:
Sonesse 28 WF RTS
Sonesse ULTRA 30 WF RTS
Batterypack

(9021028)
31,00 €



POWER SUPPLY 24 V



Power Supply
230 / 24 V DC, 1 A

(1870279)
68,00 €



SOMFY Power 24 V DC Flush
24 V DC, 1.0 A

(1870274)
171,00 €



POWER 1,5
group power supply unit, 24 V,
wire is in set

(1870149)
98,00 €



POWER 2,5
group power supply unit
with RTS receiver

(1870157)
399,00 €

MOTORS AND CONTROLS



WIRE CONTROL 24 V



POWER 2,7
group power supply unit,
24 V

(1870156)
258,00 €



ANIMEO DC
group power supply unit,
24 V, 4,5 A

(1860093)
350,00 €



Inis DC 24 V
Switch with power supply

(1870071)
178,00 €

frame not included



WIRELESS CONTROL IN THE RTS TECHNOLOGY

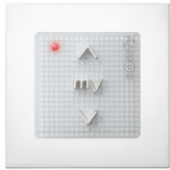

Smoove Origin RTS
(1811045 - 1-channel remote control)
59,00 €
(1800223 - 2-channel remote control)
94,00 €
(1800295 - 4-channel remote control)
115,00 €

frame is included



Situ 1 RTS II
1-channel remote control
pure *

(1870403)
55,00 €



Situ 5 RTS II
5-channel remote control
pure *

(1870419)
98,00 €



Telis 16 Pure RTS
16-channel remote control
white *

(1811079)
222,00 €



Telis Chronis Pure 6 RTS
1-channel remote control
white *

(1805215)
222,00 €



DRAHTLOSE STEUERUNG IN DER ZIGBEE-TECHNOLOGIE



zigbee
Ysia 1 Zigbee
1-channel remote control
white

(1871397)
65,00 €



zigbee
Ysia 5 Zigbee
5-channel remote control
white

(1871399)
85,00 €

*other colours are available

PHOTO: SOMFY



MOTORS AND CONTROLS



RECEIVERS RTS 24 V



Modulis DC
external radio-broadcast
receiver RTS, 24 V

(1870138)
161,00 €



Concept 25 DC
internal radio
receiver RTS

(1870143)
142,00 €



POWER 2,5 DC
external radio-broadcast
receiver RTS, with 24 V
power supply

(1870157)
399,00 €



CONTROL CENTRE



TaHoma® Switch
Smart Home control centre

(1870594)
286,00 €



CONTROL IN THE SIMU HZ TECHNOLOGY

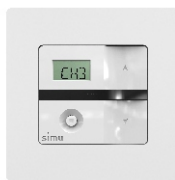

Simu Hz
5-channel transmitter
wall-mounted

(2008335)
91,00 €



Simu Hz
5-channel transmitter
portable

(2008798)
86,00 €



SIMU transmitters are compatible
with all SOMFY motors in the RTS
technology.

MOTOR AND CONTROLS



RTS / BI-DIRECTIONAL MOTORS



BREL Juno BJE24D
0,8 Nm | 34 rpm | 12 V | JST

165,00 €



BREL Juno BJE24TD
2x0,6 Nm | 34 rpm | 12 V | JST
for models: P1910, P1912, P1915,
P1920, P1922, P1925

274,00 €



 **matter**
BREL Matter BJEM24D
0,8 Nm / 34 rpm / 12 V

175,00 €



BREL Juno BJE24TR
2x0,6 Nm | 34 rpm | 12 V | JST
for models: P1950

308,00 €



CONTROLS



„One” Remote control
Single-channel remote control

(DD-2700)
51,00 €



„Multi” Remote control
15-channel remote control

(DD-2702)
60,00 €



DD-1862 Remote control
15-channel remote control
**(only for motors:
BJE24TD and BJE24TR)**

(DD-1862)
79,00 €



DD-2762 Remote control
15-channel remote control
**(only for motors:
BJE24TD and BJE24TR)**

(DD-2762)
63,00 €



„One” Switch:
Single

(DD-2770)
47,00 €



**„Multi Display”
Switch**
15-channel switch

(DD-2773)
55,00 €



BREL HOME Hub
Bi-directional
Switchboard with app
operation

(DD-1554)
195,00 €



MOTORS AND CONTROLS



ACCESSORIES



**Charger with
DIN-connector**
230 / 12 V DC

(DC-212)
32,00 €



**12V Power supply with
JST connector**
for charging batteries

(DC-202)
32,00 €



12V Battery
Li-ion 950 mAh

(DC-1201)
46,00 €



12V Battery
Li-ion 950 mAh
USB-C / JST

(DC-1330)
68,00 €



12V Battery
Li-ion 2600 mAh

(DC-1277)
86,00 €
Battery also available
in black color (DC-1277B)



12V Battery
Li-ion 2600 mAh
USB-C / JST

(DC-1278 B)
80,00 €
Battery also available
in white color (DC-1278 W)



Group power supply
for 12V motor

(DC-232w)
53,00 €



JST Cable
for group power supply
(1 male+ 2 female)

(Z-43-001)
10,00 €



Cable mit JST-Stecker
different lengths

(Z-41)
25 / 50 cm - **11,00 €**
100 cm - **12,00 €**
200 cm - **13,10 €**



Cable with DIN connector
different lengths

(Z-41)
25 / 50 cm - **11,00 €**
100 cm - **12,00 €**
200 cm - **13,10 €**



Solar panel
with DIN connector
with enclosure

554 x 65 x 10 mm
(NC-1290)
88,00 €



Sonnenkollektor
mit USB-C Stecker

570 x 30 x 25 mm
(NC-4090)
78,00 €



Solar panel
with DIN connector
without enclosure

530 x 60 x 10 mm
(NC-1291)
88,00 €



MOTORS AND CONTROLS

MotionBlinds coulisse

DECORATION SOLUTIONS



MOTOR



MOTOR 12V
BLUETOOTH/WI-FI/RADIO CONTROL



CM-07
0,8 Nm | 34 rpm | 12V

189,00 €



CONTROLLER



CM-13
15-channel remote control

57,00 €



CM-12
five channel remote control

38,00 €



CM-19
control center

203,00 €



CM-20
Wi-Fi bridge

265,00 €



CMD-01
Mini Wi-Fi bridge

142,00 €



ACCESSORIES



CM-21
power supply 12V

32,00 €



CM-39
battery 12 V Li-ion 2600 mAh
USB-C

134,00 €



CM-38
battery 12 V Li-ion 950 mAh
USB-C

48,00 €

GENERAL TERMS AND CONDITIONS OF WARRANTY

- 1** SHADOW-SYSTEM Sp. z o.o. with its seat in Kawle Dolne 4F, 83-304, Przodkowo, hereafter referred to as Guarantor, warrants good quality and smooth operation of a new product, according to standards provided for a given type of products, subject to their intended use, under normal conditions.
- 2** SHADOW-SYSTEM Sp. z o.o. provides the warranty for:
 - 36 months from the date of purchase system for pleated blind, roller blind venetian blinds,
 - 12 months from the date of purchase of fabrics, wooden and aluminium slats.
- 3** The warranty covers only defects in product resulting from the Manufacturer's fault. For such it shall be deemed the use of defective materials, production faults and construction errors.
- 4** During a physical reception of product in the Guarantor's headquarter or on the product delivery day by a freight company, the Buyer is obliged to check the quality, dimensions and the completeness of delivered product according to the order, otherwise the right to make a complaint regarding quality and delivery completeness will be forfeit.
- 5** Upon discovery of a defect in a product, the Buyer is obliged to notify it to the Guarantor within 14 days. Failure to comply with anyone of the above-mentioned conditions will result in losing the warranty rights.
- 6** All claims under the warranty are considered in the Guarantor's headquarter only (SHADOW-SYSTEM Sp. z o.o., Kawle Dolne 4F, 83-304 Przodkowo). The Parties shall individually agree on the way for returning a product to the above headquarter.
- 7** The basis for making a claim under the warranty is a properly filled in warranty card, original bill of purchase (receipt or invoice) and a completely filled in complaint document.
- 8** The completed complaint form, scanned bill of purchase as well as comprehensive photographic documentation shall be sent to the e-mail address: info@shadow-system.pl
- 9** Guarantor is obliged to investigate the legitimacy of a claim under the warranty within 14 days after receiving a written complaint, and in case if visual inspection of goods with defect is necessary, within 14 days after the date of returning goods to the Guarantor's headquarter.
- 10** Guarantor shall not be liable in case of:
 - mechanical damage or damage due to misuse or negligent handling, storing or using under improper conditions,
 - natural wear and tear of original elements, parts and accessories caused by their normal use,
 - modification of original product and interference into its structure by third parties, as well as use of other spare parts or accessories than those recommended by the Guarantor,
 - any repairs made by unauthorised personnel,
 - mounting inconsistent with good construction practices and with manufacturer's instructions, ,
 - use inconsistent with the user manual,
 - smells emitted by the product, coming from components used for the production (e.g. natural smell of bamboo slats),
 - natural small plane deformation of aluminium slats, wooden slats and fabrics surfaces,
 - differences in shades and texture of wooden slats due to natural characteristics of timber,
 - discolouration and other changes on the surface of elements caused by weather conditions,
 - differences in colours between a ready-made product and an outdated sampler or catalogue,
 - maintenance, cleaning the products, battery replacement in electrical components,
 - damage due to random incidents (fire, flood, lightning, low or too high temperatures and any other natural disasters).
- 11** Products exceeding minimum and maximum recommended dimensions specified in the technical information shall not be subject to the General Terms and Conditions of Warranty and are made to the sole responsibility of the Buyer. In such case the Guarantor shall make every effort to provide a fully functional product.
- 12** If the complaint is accepted, the Guarantor agrees to repair or replace the defective product as soon as possible.
- 13** Should a repair or replacement be impossible or should it require excessive costs, the Guarantor undertakes to take defective product back and return the purchase cost.
- 14** If the complaint is accepted and it is impossible to remove the manufacturing defects of the aluminium slats, wooden slats or fabrics because of e.g. withdrawal from the offer within the warranty period, the Guarantor may suggest a replacement for a colour-similar component.
- 15** In case the complaint is rejected, the product is returned at the Buyer's expense.
- 16** The warranty for the consumer goods within the meaning of the Act of 27.07.2002 on specific conditions of consumer sales and on the amendment to the Civil Code (Dz.U. 2002/141/1176), shall not exclude, limit or suspend the Customer rights when the provided product is inconsistent with the purchase agreement.



Shadow-System Sp. z o. o.
Kawle Dolne 4F,
83-304 Przodkowo
tel. +48 58 550 08 80
fax. +48 58 550 76 52
info@shadow-system.pl
www.shadow-system.pl



Pleated Blinds
Retail Price List